



## Leuchte

# Vali80-T

179-605W-10GGD/930, S



Bei den Leuchten Vali80-T ist es uns gelungen, die Abmessungen zu minimieren und gleichzeitig sehr gute Lichtparameter zu erhalten. Wir haben es geschafft, das Gehäuse der Leuchte bis auf 75 % der Fläche zu reduzieren. Die Leuchten bieten direkte Ausstrahlung, vier verschiedene Ausstrahlungswinkel 18°, 25°, 32°, 52° sowie austauschbare Scheinwerfer als optionales Zubehör. Sie werden hauptsächlich für die Beleuchtung von Geschäftsräumen, Galerien oder Ausstellungsräumen verwendet. In die Leuchten wurden Adapter für die 3ph-Schiene Global Track von der Firma Nordic Aluminium implementiert. Vali80-T verwenden Leuchtmittel mit einem Farbwiedergabeindex von Ra90, der dazu beiträgt, die Farben der beleuchteten Objekte getreuer darzustellen.

Typ der Montage	Schienenleuchten
Typ der Ausstrahlung	Direkte
Form der Leuchte	Rundleuchte
Farbe der Leuchte	Silber
Material	Aluminium
Lebensdauer	L90/B50 60 000 Stunden
Garantie	5 years
Beschreibung der Leuchte	Schienenleuchte
Abmessungen	ø 80 mm × 160 mm
Gewicht	0.7 kg
Lichtquelle	LED MODUL
Art der Optik	Reflektor
Lichtstrom*	1880 lm
Farbtemperatur	3000 K Warm weiss
Leuchtwirkungsgrad	92 lm/W
MacAdam Lichtquelle	3
Farbwiedergabeindex	90
Leistungsaufnahme*	20.4 W
Anschluss der Leuchte	DALI
Elektrische Spannung	220-240V
Frequenz	50/60Hz

 **CE IP 20**

\*±10 %

# Technische Zeichnung

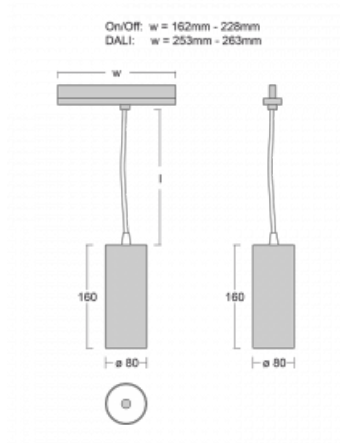

**Zum Herunterladen**

Montageanleitung



Fotografie



**Zubehör**



**00-00300, N**  
Seilaufhängung  
2000mm



**00-00301, N**  
Seilaufhängung  
4000mm



**00-00302, N**  
Seilaufhängung  
6000mm



**00-00363, K**  
Kabel 5x1,5 2000mm



**00-00364, K**  
Kabel 5x1,5 4000mm



**00-00365, K**  
Kabel 5x1,5 6000mm



**00-00370, B**  
Deckenkappe  
80x80x32mm



**00-00370, S**  
Deckenkappe  
80x80x32mm



**00-00370, W**  
Deckenkappe  
80x80x32mm



**SKB10-1, grey**



**SKB10-2, black**



**SKB10-3, white**



**SKB12-1, grey**



**SKB12-2, black**

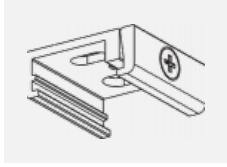

**SKB12-3, white**

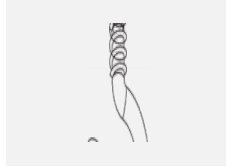

**XTAK11-1, grey**



**XTAK142-1, grey**



**XTAK142-2, black**



**XTAK142-3, white**

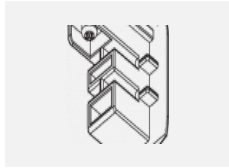

**XTS41-1, grey**



**XTS41-2, black**

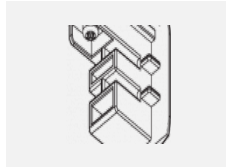

**XTS41-3, white**

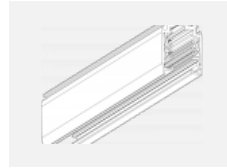

**XTSC6100-1, grey**



**XTSC6100-2, black**



**XTSC6100-3, white**



**XTSC611-1, grey**

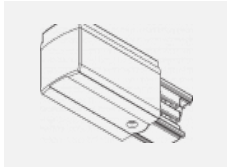

**XTSC611-2, black**

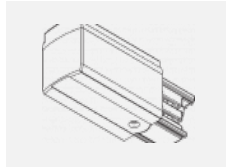

**XTSC611-3, white**

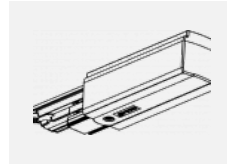

**XTSC612-1, grey**

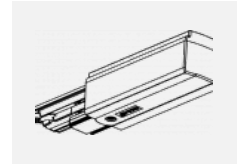

**XTSC612-2, black**

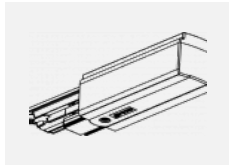

**XTSC612-3, white**

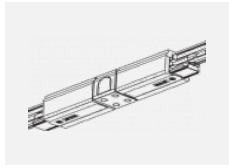

**XTSC614-1, grey**

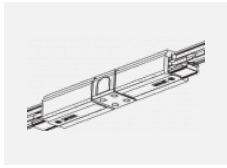

**XTSC614-2, black**

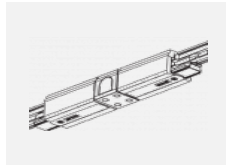

**XTSC614-3, white**

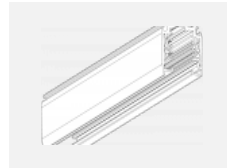

**XTSC6200-1, grey**



**XTSC6200-2, black**



**XTSC6200-3, white**

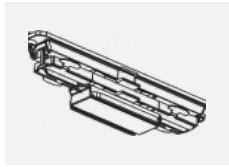

**XTSC621-1, grey**

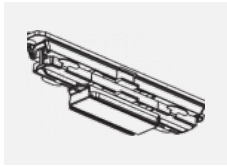

**XTSC621-2, black**

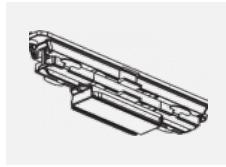

**XTSC621-3, white**

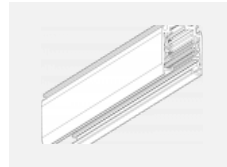

**XTSC6300-1, grey**



**XTSC6300-2, black**



XTSC6300-3, white



XTSC634-1, grey



XTSC634-2, black



XTSC634-3, white



XTSC635-1, grey



XTSC635-2, black



XTSC635-3, white



XTSC636-2, black



XTSC636-3, white



XTSC637-1, grey



XTSC637-2, black



XTSC637-3, white



XTSC638-1, grey



XTSC638-2, black



XTSC638-3, white



XTSC639-1, grey



XTSC639-2, black



XTSC639-3, white



XTSC640-1, grey



XTSC640-2, black



XTSC640-3, white



XTSC6400-1, grey



XTSC6400-2, black



XTSC6400-3, white



XTSCF6100-1, grey



XTSCF6100-2, black



XTSCF6100-3, white



XTSCF6200-1, grey



XTSCF6200-2, black



XTSCF6200-3, white



XTSCF6300-1, grey



XTSCF6300-2, black



XTSCF6300-3, white



XTSCF6400-1, grey



XTSCF6400-2, black



XTSCF6400-3, white



XTSV12-1, grey