

Leuchte

Vali80-T

179-605F-10GHE/930, B



Bei den Leuchten Vali80-T ist es uns gelungen, die Abmessungen zu minimieren und gleichzeitig sehr gute Lichtparameter zu erhalten. Wir haben es geschafft, das Gehäuse der Leuchte bis auf 75 % der Fläche zu reduzieren. Die Leuchten bieten direkte Ausstrahlung, vier verschiedene Ausstrahlungswinkel 18°, 25°, 32°, 52° sowie austauschbare Scheinwerfer als optionales Zubehör. Sie werden hauptsächlich für die Beleuchtung von Geschäftsräumen, Galerien oder Ausstellungsräumen verwendet. In die Leuchten wurden Adapter für die 3ph-Schiene Global Track von der Firma Nordic Aluminium implementiert. Vali80-T verwenden Leuchtmittel mit einem Farbwiedergabeindex von Ra90, der dazu beiträgt, die Farben der beleuchteten Objekte getreuer darzustellen.

Typ der Montage	Schienenleuchten
Typ der Ausstrahlung	Direkte
Form der Leuchte	Rundleuchte
Farbe der Leuchte	Schwarz
Material	Aluminium
Lebensdauer	L80/B10 60 000 Stunden
Garantie	5 years
Beschreibung der Leuchte	Schienenleuchte
Abmessungen	ø 80 mm × 160 mm
Gewicht	0.7 kg
Lichtquelle	LED MODUL
Art der Optik	Reflektor
Lichtstrom*	2830 lm
Farbtemperatur	3000 K Warm weiss
Leuchtwirkungsgrad	86 lm/W
MacAdam Lichtquelle	3
Farbwiedergabeindex	90
Leistungsaufnahme*	33 W
Anschluss der Leuchte	ON/OFF
Elektrische Spannung	220-240V
Frequenz	50/60Hz

 **CE IP 20**

*±10 %

Technische Zeichnung

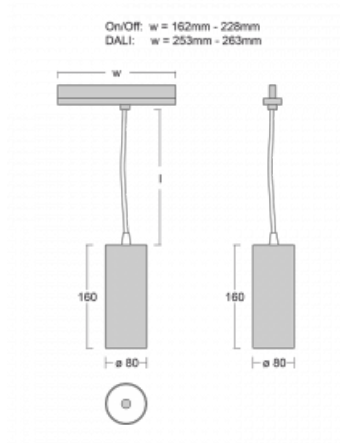

Zum Herunterladen

Montageanleitung



Fotografie



Zubehör

00-00300, N
 Seilaufhängung
 2000mm

00-00301, N
 Seilaufhängung
 4000mm

00-00302, N
 Seilaufhängung
 6000mm

00-00363, K
 Kabel 5x1,5 2000mm

00-00364, K
 Kabel 5x1,5 4000mm

00-00365, K
 Kabel 5x1,5 6000mm

00-00370, B
 Deckenkappe
 80x80x32mm

00-00370, S
 Deckenkappe
 80x80x32mm

00-00370, W
 Deckenkappe
 80x80x32mm

SKB10-1, grey

SKB10-2, black

SKB10-3, white

SKB12-1, grey

SKB12-2, black

SKB12-3, white

XTAK11-1, grey

XTAK142-1, grey

XTAK142-2, black

XTAK142-3, white

XTS11-1, grey

XTS11-2, black

XTS11-3, white

XTS12-1, grey

XTS12-2, black

XTS12-3, white

XTS14-1, grey

XTS14-2, black

XTS14-3, white

XTS21-1, grey

XTS21-2, black

XTS21-3, white

XTS24-1, grey

XTS24-2, black

XTS24-3, white

XTS34-1, grey

XTS34-2, black

XTS34-3, white

XTS35-1, grey

XTS35-2, black

XTS35-3, white

XTS36-1, grey

XTS36-2, black



XTS36-3, white



XTS37-1, grey



XTS37-2, black



XTS37-3, white



XTS38-1, grey



XTS38-2, black

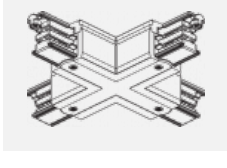

XTS38-3, white

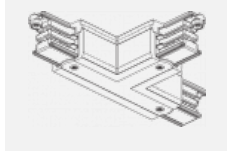

XTS39-1, grey

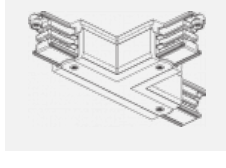

XTS39-2, black

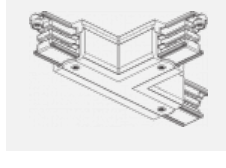

XTS39-3, white

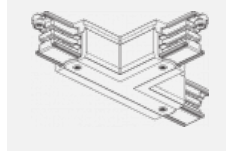

XTS40-1, grey

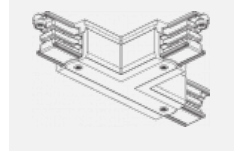

XTS40-2, black

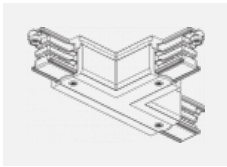

XTS40-3, white

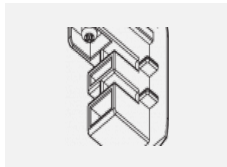

XTS41-1, grey

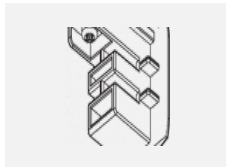

XTS41-2, black

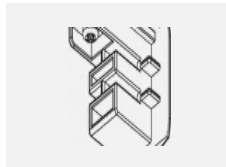

XTS41-3, white

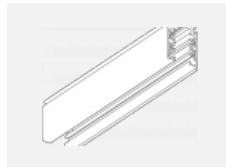

XTS4100-1, grey



XTS4100-2, black



XTS4100-3, white



XTS4200-1, grey



XTS4200-2, black



XTS4200-3, white



XTS4300-1, grey



XTS4300-2, black



XTS4300-3, white



XTS4400-1, grey



XTS4400-2, black



XTS4400-3, white



XTSF4100-1, grey



XTSF4100-2, black



XTSF4100-3, white



XTSF4200-1, grey



XTSF4200-2, black



XTSF4200-3, white



XTSF4300-1, grey



XTSF4300-2, black



XTSF4300-3, white



XTSF4400-1, grey



XTSF4400-2, black



XTSF4400-3, white



XTSV12-1, grey