



Leuchte

Vali80-T

179-605F-10GGD/940, S



Bei den Leuchten Vali80-T ist es uns gelungen, die Abmessungen zu minimieren und gleichzeitig sehr gute Lichtparameter zu erhalten. Wir haben es geschafft, das Gehäuse der Leuchte bis auf 75 % der Fläche zu reduzieren. Die Leuchten bieten direkte Ausstrahlung, vier verschiedene Ausstrahlungswinkel 18°, 25°, 32°, 52° sowie austauschbare Scheinwerfer als optionales Zubehör. Sie werden hauptsächlich für die Beleuchtung von Geschäftsräumen, Galerien oder Ausstellungsräumen verwendet. In die Leuchten wurden Adapter für die 3ph-Schiene Global Track von der Firma Nordic Aluminium implementiert. Vali80-T verwenden Leuchtmittel mit einem Farbwiedergabeindex von Ra90, der dazu beiträgt, die Farben der beleuchteten Objekte getreuer darzustellen.

Typ der Montage	Schienenleuchten
Typ der Ausstrahlung	Direkte
Form der Leuchte	Rundleuchte
Farbe der Leuchte	Silber
Material	Aluminium
Lebensdauer	L90/B50 60 000 Stunden
Garantie	5 years
Beschreibung der Leuchte	Schienenleuchte
Abmessungen	ø 80 mm × 160 mm
Gewicht	0.7 kg
Lichtquelle	LED MODUL
Art der Optik	Reflektor
Lichtstrom*	1970 lm
Farbtemperatur	4000 K Kalt weiss
Leuchtwirkungsgrad	97 lm/W
MacAdam Lichtquelle	3
Farbwiedergabeindex	90
Leistungsaufnahme*	20.4 W
Anschluss der Leuchte	DALI
Elektrische Spannung	220-240V
Frequenz	50/60Hz

 **CE IP 20**

*±10 %

Technische Zeichnung

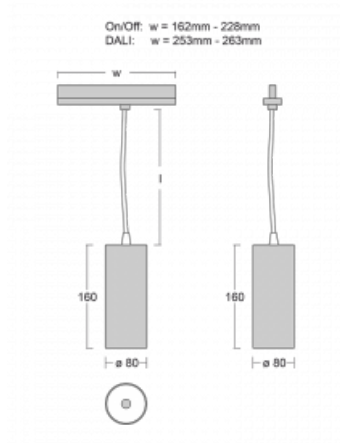

Zum Herunterladen

Montageanleitung



Fotografie



Zubehör

00-00300, N
 Seilaufhängung
 2000mm

00-00301, N
 Seilaufhängung
 4000mm

00-00302, N
 Seilaufhängung
 6000mm

00-00363, K
 Kabel 5x1,5 2000mm

00-00364, K
 Kabel 5x1,5 4000mm

00-00365, K
 Kabel 5x1,5 6000mm

00-00370, B
 Deckenkappe
 80x80x32mm

00-00370, S
 Deckenkappe
 80x80x32mm

00-00370, W
 Deckenkappe
 80x80x32mm

SKB10-1, grey

SKB10-2, black

SKB10-3, white

SKB12-1, grey

SKB12-2, black

SKB12-3, white

XTAK11-1, grey

XTAK142-1, grey

XTAK142-2, black

XTAK142-3, white

XTS41-1, grey

XTS41-2, black

XTS41-3, white

XTSC6100-1, grey

XTSC6100-2, black

XTSC6100-3, white

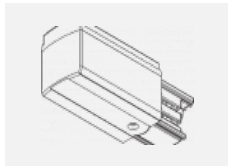
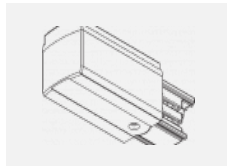
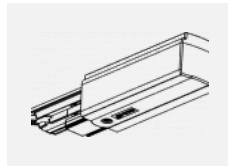
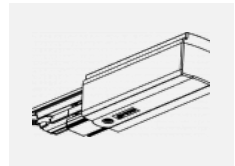
XTSC611-1, grey

XTSC611-2, black

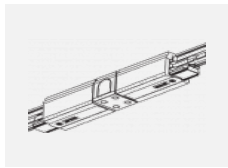
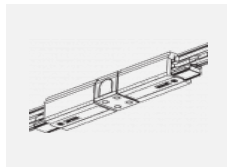
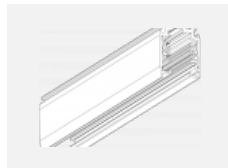
XTSC611-3, white

XTSC612-1, grey

XTSC612-2, black

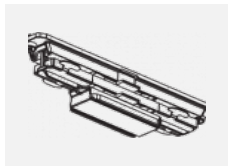
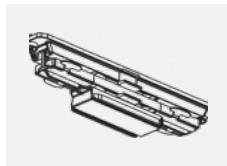
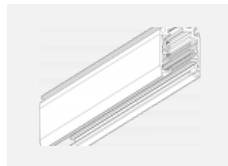
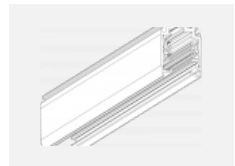
XTSC612-3, white

XTSC614-1, grey

XTSC614-2, black

XTSC614-3, white

XTSC6200-1, grey

XTSC6200-2, black

XTSC6200-3, white

XTSC621-1, grey

XTSC621-2, black

XTSC621-3, white

XTSC6300-1, grey

XTSC6300-2, black



XTSC6300-3, white



XTSC634-1, grey



XTSC634-2, black



XTSC634-3, white



XTSC635-1, grey



XTSC635-2, black



XTSC635-3, white



XTSC636-2, black



XTSC636-3, white



XTSC637-1, grey



XTSC637-2, black



XTSC637-3, white



XTSC638-1, grey



XTSC638-2, black



XTSC638-3, white



XTSC639-1, grey



XTSC639-2, black



XTSC639-3, white



XTSC640-1, grey



XTSC640-2, black



XTSC640-3, white



XTSC6400-1, grey



XTSC6400-2, black



XTSC6400-3, white



XTSCF6100-1, grey



XTSCF6100-2, black



XTSCF6100-3, white



XTSCF6200-1, grey



XTSCF6200-2, black



XTSCF6200-3, white



XTSCF6300-1, grey



XTSCF6300-2, black



XTSCF6300-3, white



XTSCF6400-1, grey



XTSCF6400-2, black



XTSCF6400-3, white



XTSV12-1, grey