



Leuchte

Vali80-T

179-605F-10GDD/930, S



Bei den Leuchten Vali80-T ist es uns gelungen, die Abmessungen zu minimieren und gleichzeitig sehr gute Lichtparameter zu erhalten. Wir haben es geschafft, das Gehäuse der Leuchte bis auf 75 % der Fläche zu reduzieren. Die Leuchten bieten direkte Ausstrahlung, vier verschiedene Ausstrahlungswinkel 18°, 25°, 32°, 52° sowie austauschbare Scheinwerfer als optionales Zubehör. Sie werden hauptsächlich für die Beleuchtung von Geschäftsräumen, Galerien oder Ausstellungsräumen verwendet. In die Leuchten wurden Adapter für die 3ph-Schiene Global Track von der Firma Nordic Aluminium implementiert. Vali80-T verwenden Leuchtmittel mit einem Farbwiedergabeindex von Ra90, der dazu beiträgt, die Farben der beleuchteten Objekte getreuer darzustellen.

Typ der Montage	Schienenleuchten
Typ der Ausstrahlung	Direkte
Form der Leuchte	Rundleuchte
Farbe der Leuchte	Silber
Material	Aluminium
Lebensdauer	L90/B50 60 000 Stunden
Garantie	5 years
Beschreibung der Leuchte	Schienenleuchte
Abmessungen	ø 80 mm × 160 mm
Gewicht	0.7 kg
Lichtquelle	LED MODUL
Art der Optik	Reflektor
Lichtstrom*	990 lm
Farbtemperatur	3000 K Warm weiss
Leuchtwirkungsgrad	99 lm/W
MacAdam Lichtquelle	3
Farbwiedergabeindex	90
Leistungsaufnahme*	10 W
Anschluss der Leuchte	DALI
Elektrische Spannung	220-240V
Frequenz	50/60Hz

 **CE IP 20**

*±10 %

Technische Zeichnung

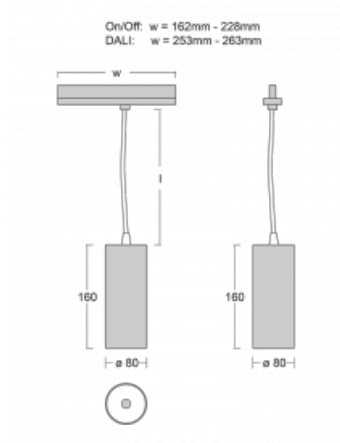

Zum Herunterladen

Montageanleitung



Fotografie



Zubehör



00-00300, N
Seilabhängung
2000mm



00-00301, N
Seilabhängung
4000mm



00-00302, N
Seilabhängung
6000mm



00-00363, K
Kabel 5x1,5 2000mm



00-00364, K
Kabel 5x1,5 4000mm



00-00365, K
Kabel 5x1,5 6000mm



00-00370, B
Deckenkappe
80x80x32mm



00-00370, S
Deckenkappe
80x80x32mm



00-00370, W
Deckenkappe
80x80x32mm

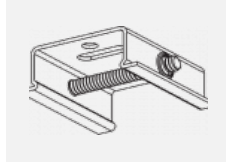

SKB10-1, grey

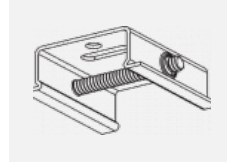

SKB10-2, black

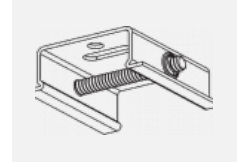

SKB10-3, white



SKB12-1, grey



SKB12-2, black

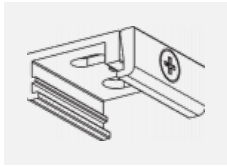

SKB12-3, white



XTAK11-1, grey



XTAK142-1, grey



XTAK142-2, black



XTAK142-3, white



XTS41-1, grey

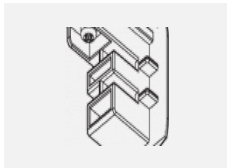

XTS41-2, black

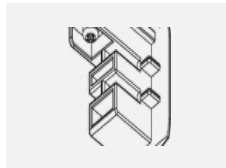

XTS41-3, white

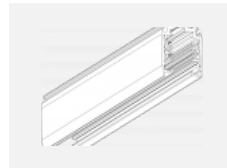

XTSC6100-1, grey



XTSC6100-2, black

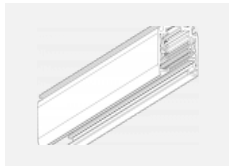

XTSC6100-3, white

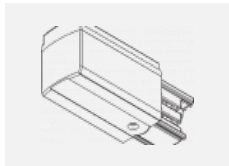

XTSC611-1, grey

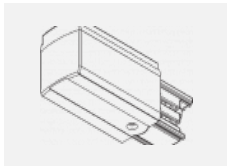

XTSC611-2, black

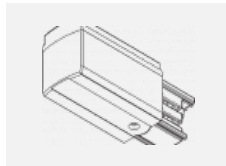

XTSC611-3, white

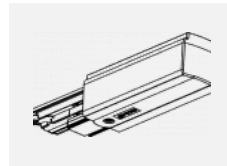

XTSC612-1, grey

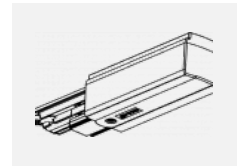

XTSC612-2, black

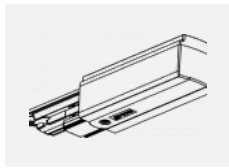

XTSC612-3, white

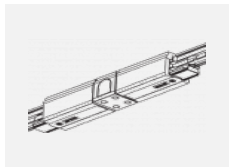

XTSC614-1, grey

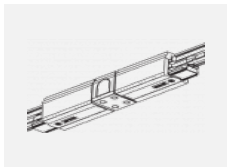

XTSC614-2, black

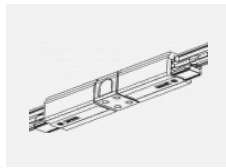

XTSC614-3, white

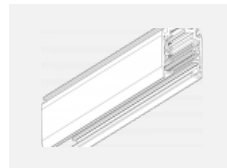

XTSC6200-1, grey



XTSC6200-2, black

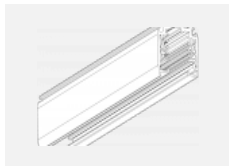

XTSC6200-3, white

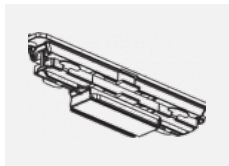

XTSC621-1, grey

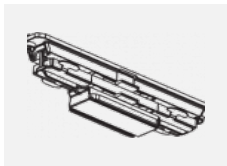

XTSC621-2, black

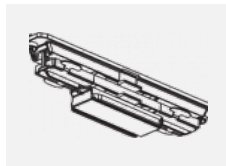

XTSC621-3, white

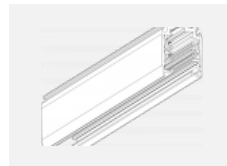

XTSC6300-1, grey

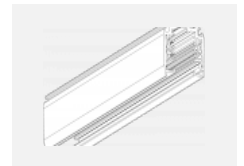

XTSC6300-2, black



XTSC6300-3, white

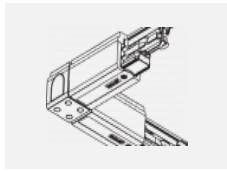

XTSC634-1, grey

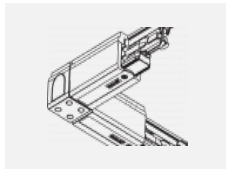

XTSC634-2, black

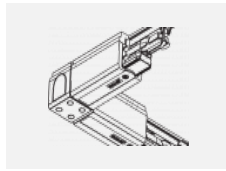

XTSC634-3, white

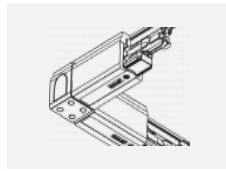

XTSC635-1, grey

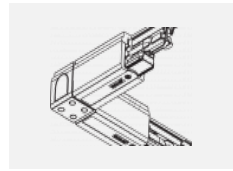

XTSC635-2, black



XTSC635-3, white

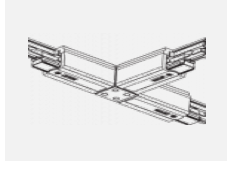

XTSC636-2, black

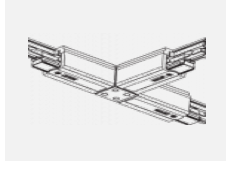

XTSC636-3, white

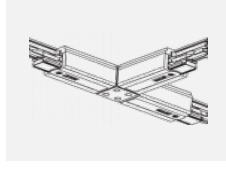

XTSC637-1, grey

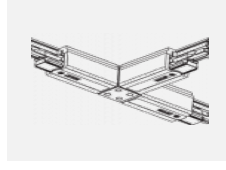

XTSC637-2, black

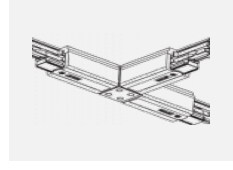

XTSC637-3, white

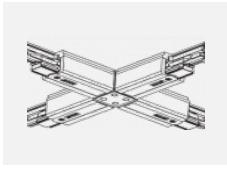

XTSC638-1, grey

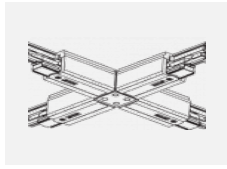

XTSC638-2, black

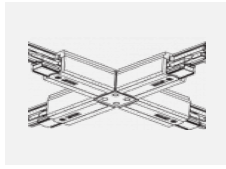

XTSC638-3, white

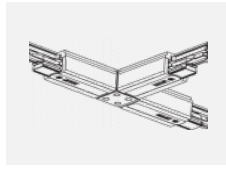

XTSC639-1, grey

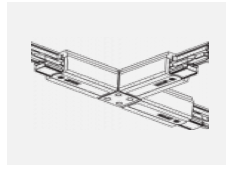

XTSC639-2, black

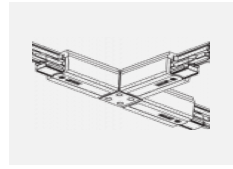

XTSC639-3, white

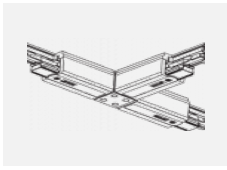

XTSC640-1, grey

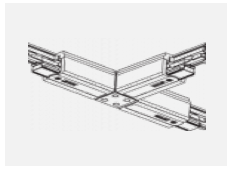

XTSC640-2, black

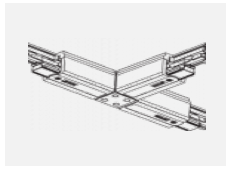

XTSC640-3, white

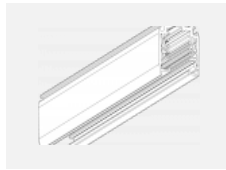

XTSC6400-1, grey

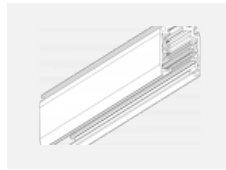

XTSC6400-2, black

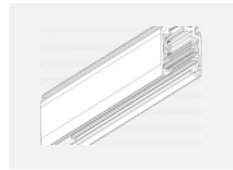

XTSC6400-3, white

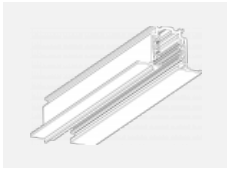

XTSCF6100-1, grey



XTSCF6100-2, black

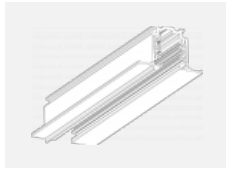

XTSCF6100-3, white



XTSCF6200-1, grey



XTSCF6200-2, black

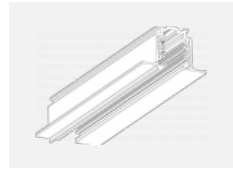

XTSCF6200-3, white



XTSCF6300-1, grey



XTSCF6300-2, black



XTSCF6300-3, white



XTSCF6400-1, grey



XTSCF6400-2, black



XTSCF6400-3, white



XTSV12-1, grey