



**Leuchte**

# Vali55-T

178-605U-10GGE/930, B

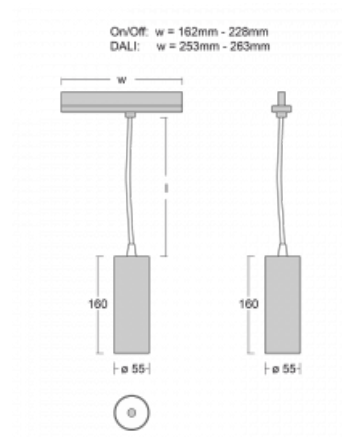

Wenn Sie eine wirklich dezent aussehende zylindrische Trackleuchte mit kleinen Abmessungen, einer hochwertigen Aluminiumkonstruktion und guten Lichtparametern suchen, gibt es nicht viel zu überlegen, die Leuchte Vali55-T ist genau das Richtige für Sie. Sie findet Anwendung vor allem bei der Beleuchtung kleinerer Verkaufsflächen wie z. B. Vitrinen oder bei der Anstrahlung eines bestimmten Produkts. Sie kann aber auch zur Beleuchtung von Kunstobjekten und in einigen Fällen auch in Privatwohnungen eingesetzt werden. In die Leuchten wurden Adapter für die 3ph-Schiene Global Track von der Firma Nordic Aluminium implementiert.

**Technische Zeichnung**

|                          |                        |
|--------------------------|------------------------|
| Typ der Montage          | Schienenleuchten       |
| Typ der Ausstrahlung     | Direkte                |
| Form der Leuchte         | Rundleuchte            |
| Farbe der Leuchte        | Schwarz                |
| Material                 | Aluminium              |
| Lebensdauer              | L80/B20 50 000 Stunden |
| Garantie                 | 5 years                |
| Beschreibung der Leuchte | Schienenleuchte        |
| Abmessungen              | ø 55 mm × 160 mm       |
| Gewicht                  | 0.5 kg                 |
| Lichtquelle              | LED MODUL              |
| Art der Optik            | Reflektor              |
| Lichtstrom*              | 1650 lm                |
| Farbtemperatur           | 3000 K Warm weiss      |
| Leuchtwirkungsgrad       | 83 lm/W                |
| MacAdam Lichtquelle      | 3                      |
| Farbwiedergabeindex      | 90                     |
| Leistungsaufnahme*       | 20 W                   |
| Anschluss der Leuchte    | ON/OFF                 |
| Elektrische Spannung     | 220-240V               |
| Frequenz                 | 50/60Hz                |

 **CE IP 20**

\*±10 %

## Zum Herunterladen

Montageanleitung



Fotografie



**Zubehör**

**00-00300, N**  
 Seilaufhängung  
 2000mm

**00-00301, N**  
 Seilaufhängung  
 4000mm

**00-00302, N**  
 Seilaufhängung  
 6000mm

**00-00363, K**  
 Kabel 5x1,5 2000mm

**00-00364, K**  
 Kabel 5x1,5 4000mm

**00-00365, K**  
 Kabel 5x1,5 6000mm

**00-00370, B**  
 Deckenkappe  
 80x80x32mm

**00-00370, S**  
 Deckenkappe  
 80x80x32mm

**00-00370, W**  
 Deckenkappe  
 80x80x32mm

**SKB10-1, grey**

**SKB10-2, black**

**SKB10-3, white**

**SKB12-1, grey**

**SKB12-2, black**

**SKB12-3, white**

**XTAK11-1, grey**

**XTAK142-1, grey**

**XTAK142-2, black**

**XTAK142-3, white**

**XTS11-1, grey**

**XTS11-2, black**

**XTS11-3, white**

**XTS12-1, grey**

**XTS12-2, black**

**XTS12-3, white**

**XTS14-1, grey**

**XTS14-2, black**

**XTS14-3, white**

**XTS21-1, grey**

**XTS21-2, black**

**XTS21-3, white**

**XTS24-1, grey**

**XTS24-2, black**

**XTS24-3, white**

**XTS34-1, grey**

**XTS34-2, black**

**XTS34-3, white**

**XTS35-1, grey**

**XTS35-2, black**

**XTS35-3, white**

**XTS36-1, grey**

**XTS36-2, black**



XTS36-3, white



XTS37-1, grey



XTS37-2, black



XTS37-3, white



XTS38-1, grey

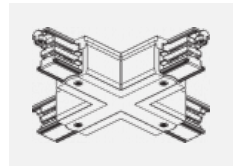

XTS38-2, black

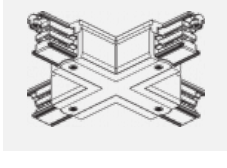

XTS38-3, white

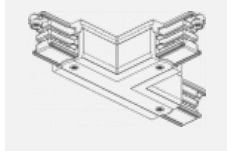

XTS39-1, grey

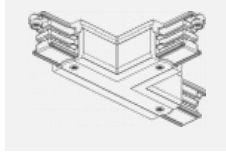

XTS39-2, black

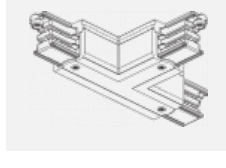

XTS39-3, white

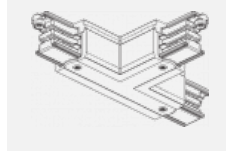

XTS40-1, grey

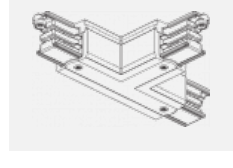

XTS40-2, black



XTS40-3, white



XTS41-1, grey



XTS41-2, black



XTS41-3, white



XTS4100-1, grey



XTS4100-2, black



XTS4100-3, white



XTS4200-1, grey



XTS4200-2, black



XTS4200-3, white



XTS4300-1, grey



XTS4300-2, black



XTS4300-3, white



XTS4400-1, grey



XTS4400-2, black



XTS4400-3, white



XTSF4100-1, grey

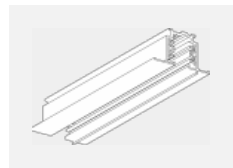

XTSF4100-2, black



XTSF4100-3, white



XTSF4200-1, grey



XTSF4200-2, black



XTSF4200-3, white



XTSF4300-1, grey

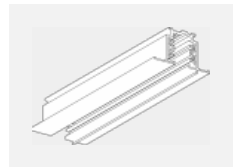

XTSF4300-2, black



XTSF4300-3, white



XTSF4400-1, grey



XTSF4400-2, black



XTSF4400-3, white



XTSV12-1, grey