



## Leuchte

# Vali55-T

178-605S-10GGD/940, B



Wenn Sie eine wirklich dezent aussehende zylindrische Trackleuchte mit kleinen Abmessungen, einer hochwertigen Aluminiumkonstruktion und guten Lichtparametern suchen, gibt es nicht viel zu überlegen, die Leuchte Vali55-T ist genau das Richtige für Sie. Sie findet Anwendung vor allem bei der Beleuchtung kleinerer Verkaufsflächen wie z. B. Vitrinen oder bei der Anstrahlung eines bestimmten Produkts. Sie kann aber auch zur Beleuchtung von Kunstobjekten und in einigen Fällen auch in Privatwohnungen eingesetzt werden. In die Leuchten wurden Adapter für die 3ph-Schiene Global Track von der Firma Nordic Aluminium implementiert.

## Technische Zeichnung

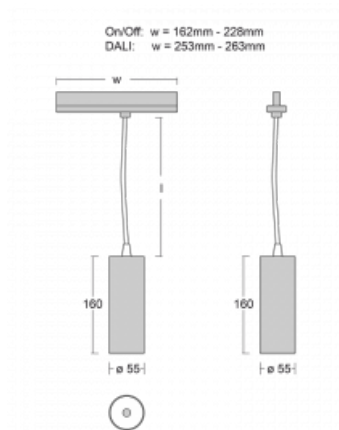

Typ der Montage	Schienenleuchten
Typ der Ausstrahlung	Direkte
Form der Leuchte	Rundleuchte
Farbe der Leuchte	Schwarz
Material	Aluminium
Lebensdauer	L80/B20 50 000 Stunden
Garantie	5 years
Beschreibung der Leuchte	Schienenleuchte
Abmessungen	ø 55 mm × 160 mm
Gewicht	0.5 kg
Lichtquelle	LED MODUL
Art der Optik	Reflektor
Lichtstrom*	1750 lm
Farbtemperatur	4000 K Kalt weiss
Leuchtwirkungsgrad	88 lm/W
MacAdam Lichtquelle	3
Farbwiedergabeindex	90
Leistungsaufnahme*	20 W
Anschluss der Leuchte	DALI
Elektrische Spannung	220-240V
Frequenz	50/60Hz

 CE IP 20

\*±10 %

**Zum Herunterladen**

Montageanleitung



Fotografie



**Zubehör**

**00-00300, N**  
 Seilabhängung  
 2000mm

**00-00301, N**  
 Seilabhängung  
 4000mm

**00-00302, N**  
 Seilabhängung  
 6000mm

**00-00363, K**  
 Kabel 5x1,5 2000mm

**00-00364, K**  
 Kabel 5x1,5 4000mm

**00-00365, K**  
 Kabel 5x1,5 6000mm

**00-00370, B**  
 Deckenkappe  
 80x80x32mm

**00-00370, S**  
 Deckenkappe  
 80x80x32mm

**00-00370, W**  
 Deckenkappe  
 80x80x32mm

**SKB10-1, grey**

**SKB10-2, black**

**SKB10-3, white**

**SKB12-1, grey**

**SKB12-2, black**

**SKB12-3, white**

**XTAK11-1, grey**

**XTAK142-1, grey**

**XTAK142-2, black**

**XTAK142-3, white**

**XTS41-1, grey**

**XTS41-2, black**

**XTS41-3, white**

**XTSC6100-1, grey**

**XTSC6100-2, black**

**XTSC6100-3, white**

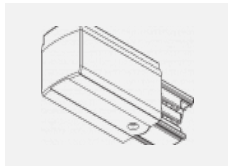
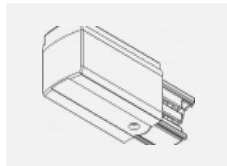
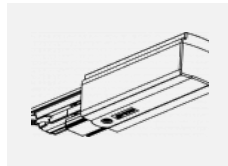
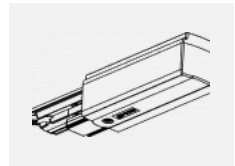
**XTSC611-1, grey**

**XTSC611-2, black**

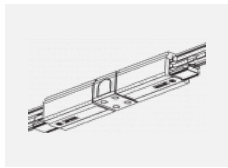
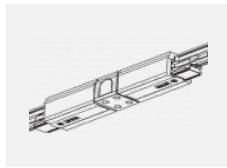
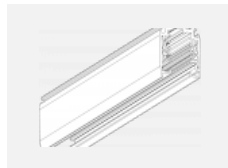
**XTSC611-3, white**

**XTSC612-1, grey**

**XTSC612-2, black**

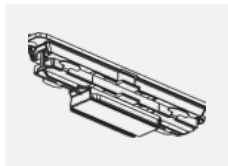
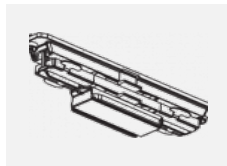
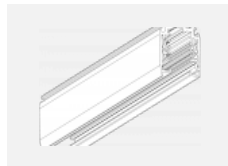
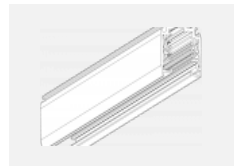
**XTSC612-3, white**

**XTSC614-1, grey**

**XTSC614-2, black**

**XTSC614-3, white**

**XTSC6200-1, grey**

**XTSC6200-2, black**

**XTSC6200-3, white**

**XTSC621-1, grey**

**XTSC621-2, black**

**XTSC621-3, white**

**XTSC6300-1, grey**

**XTSC6300-2, black**



XTSC6300-3, white



XTSC634-1, grey



XTSC634-2, black



XTSC634-3, white



XTSC635-1, grey



XTSC635-2, black



XTSC635-3, white

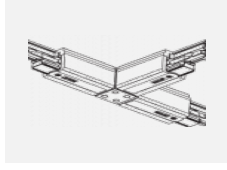

XTSC636-2, black

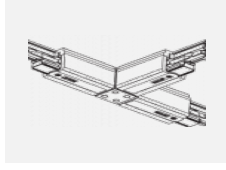

XTSC636-3, white

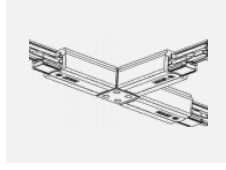

XTSC637-1, grey

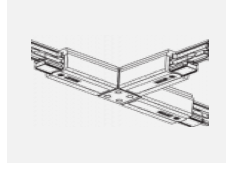

XTSC637-2, black

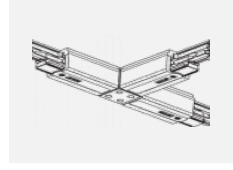

XTSC637-3, white



XTSC638-1, grey



XTSC638-2, black



XTSC638-3, white



XTSC639-1, grey



XTSC639-2, black

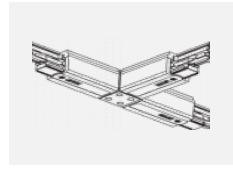

XTSC639-3, white



XTSC640-1, grey



XTSC640-2, black



XTSC640-3, white



XTSC6400-1, grey



XTSC6400-2, black

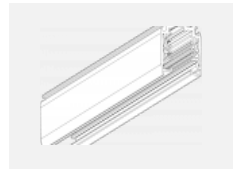

XTSC6400-3, white



XTSCF6100-1, grey



XTSCF6100-2, black



XTSCF6100-3, white



XTSCF6200-1, grey



XTSCF6200-2, black

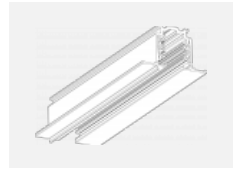

XTSCF6200-3, white



XTSCF6300-1, grey



XTSCF6300-2, black



XTSCF6300-3, white



XTSCF6400-1, grey



XTSCF6400-2, black



XTSCF6400-3, white



XTSV12-1, grey