



Leuchte

Vali55-T

178-605S-10GDE/930, W



Wenn Sie eine wirklich dezent aussehende zylindrische Trackleuchte mit kleinen Abmessungen, einer hochwertigen Aluminiumkonstruktion und guten Lichtparametern suchen, gibt es nicht viel zu überlegen, die Leuchte Vali55-T ist genau das Richtige für Sie. Sie findet Anwendung vor allem bei der Beleuchtung kleinerer Verkaufsflächen wie z. B. Vitrinen oder bei der Anstrahlung eines bestimmten Produkts. Sie kann aber auch zur Beleuchtung von Kunstobjekten und in einigen Fällen auch in Privatwohnungen eingesetzt werden. In die Leuchten wurden Adapter für die 3ph-Schiene Global Track von der Firma Nordic Aluminium implementiert.

Technische Zeichnung

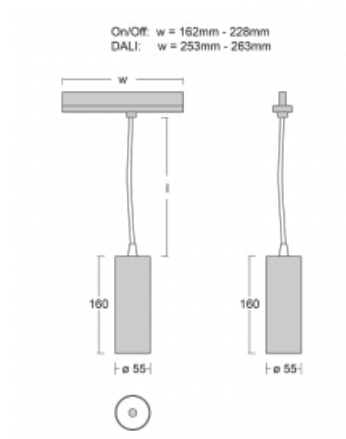

Typ der Montage	Schienenleuchten
Typ der Ausstrahlung	Direkte
Form der Leuchte	Rundleuchte
Farbe der Leuchte	Weiss
Material	Aluminium
Lebensdauer	L80/B20 50 000 Stunden
Garantie	5 years
Beschreibung der Leuchte	Schienenleuchte
Abmessungen	ø 55 mm × 160 mm
Gewicht	0.5 kg
Lichtquelle	LED MODUL
Art der Optik	Reflektor
Lichtstrom	1200 lm ± 10 %
Farbtemperatur	3000 K Warm weiss
Leuchtwirkungsgrad	88 lm/W
MacAdam Lichtquelle	3
Farbwiedergabeindex	90
Leistungsaufnahme	13.6 W ± 10 %
Anschluss der Leuchte	EVG nicht dimmbar
Elektrische Spannung	220-240V
Frequenz	50/60Hz



Zum Herunterladen

Montageanleitung



Fotografie



Zubehör

00-00300, N
 Seilaufhängung
 2000mm

00-00301, N
 Seilaufhängung
 4000mm

00-00302, N
 Seilaufhängung
 6000mm

00-00363, K
 Kabel 5x1,5 2000mm

00-00364, K
 Kabel 5x1,5 4000mm

00-00365, K
 Kabel 5x1,5 6000mm

00-00370, B
 Deckenkappe
 80x80x32mm

00-00370, S
 Deckenkappe
 80x80x32mm

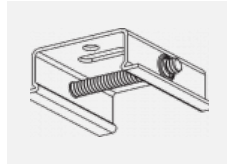
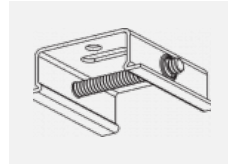
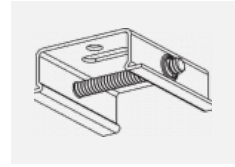
00-00370, W
 Deckenkappe
 80x80x32mm

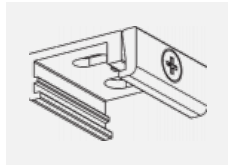
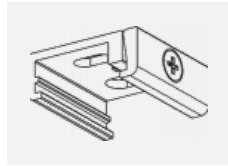
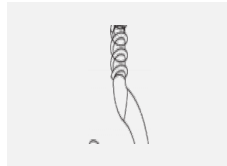
SKB10-1, grey

SKB10-2, black

SKB10-3, white

SKB12-1, grey

SKB12-2, black

SKB12-3, white

XTAK11-1, grey

XTAK142-1, grey

XTAK142-2, black

XTAK142-3, white

XTS11-1, grey

XTS11-2, black

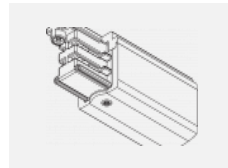
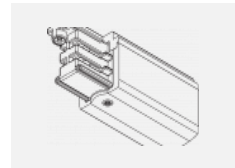
XTS11-3, white

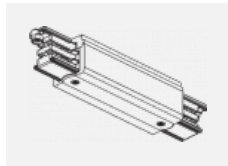
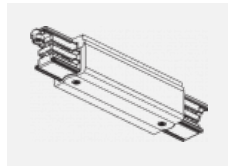
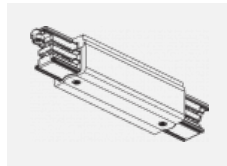
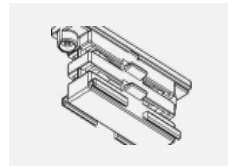
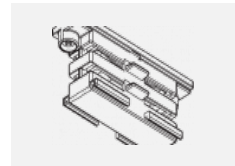
XTS12-1, grey

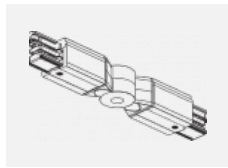
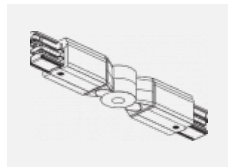
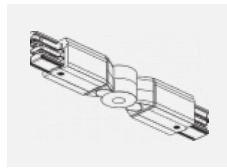
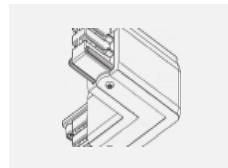
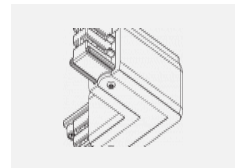
XTS12-2, black

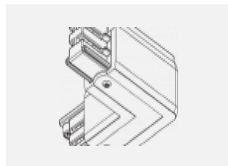
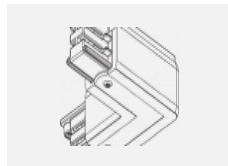
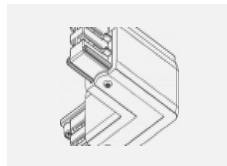
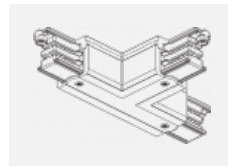
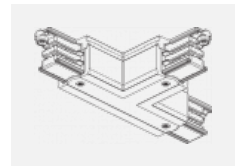
XTS12-3, white

XTS14-1, grey

XTS14-2, black

XTS14-3, white

XTS21-1, grey

XTS21-2, black

XTS21-3, white

XTS24-1, grey

XTS24-2, black

XTS24-3, white

XTS34-1, grey

XTS34-2, black

XTS34-3, white

XTS35-1, grey

XTS35-2, black

XTS35-3, white

XTS36-1, grey

XTS36-2, black



XTS36-3, white



XTS37-1, grey



XTS37-2, black



XTS37-3, white



XTS38-1, grey



XTS38-2, black



XTS38-3, white



XTS39-1, grey



XTS39-2, black



XTS39-3, white



XTS40-1, grey



XTS40-2, black



XTS40-3, white



XTS41-1, grey



XTS41-2, black



XTS41-3, white



XTS4100-1, grey



XTS4100-2, black



XTS4100-3, white



XTS4200-1, grey



XTS4200-2, black



XTS4200-3, white



XTS4300-1, grey



XTS4300-2, black



XTS4300-3, white



XTS4400-1, grey



XTS4400-2, black



XTS4400-3, white



XTSF4100-1, grey



XTSF4100-2, black



XTSF4100-3, white



XTSF4200-1, grey



XTSF4200-2, black



XTSF4200-3, white



XTSF4300-1, grey



XTSF4300-2, black



XTSF4300-3, white



XTSF4400-1, grey



XTSF4400-2, black



XTSF4400-3, white



XTSV12-1, grey