



Leuchte

Vali55-T

178-605F-10GGD/940, B



Wenn Sie eine wirklich dezent aussehende zylindrische Trackleuchte mit kleinen Abmessungen, einer hochwertigen Aluminiumkonstruktion und guten Lichtparametern suchen, gibt es nicht viel zu überlegen, die Leuchte Vali55-T ist genau das Richtige für Sie. Sie findet Anwendung vor allem bei der Beleuchtung kleinerer Verkaufsflächen wie z. B. Vitrinen oder bei der Anstrahlung eines bestimmten Produkts. Sie kann aber auch zur Beleuchtung von Kunstobjekten und in einigen Fällen auch in Privatwohnungen eingesetzt werden. In die Leuchten wurden Adapter für die 3ph-Schiene Global Track von der Firma Nordic Aluminium implementiert.

Technische Zeichnung



Typ der Montage	Schienenleuchten
Typ der Ausstrahlung	Direkte
Form der Leuchte	Rundleuchte
Farbe der Leuchte	Schwarz
Material	Aluminium
Lebensdauer	L80/B20 50 000 Stunden
Garantie	5 years
Beschreibung der Leuchte	Schienenleuchte
Abmessungen	ø 55 mm × 160 mm
Gewicht	0.5 kg
Lichtquelle	LED MODUL
Art der Optik	Reflektor
Lichtstrom*	1750 lm
Farbtemperatur	4000 K Kalt weiss
Leuchtwirkungsgrad	88 lm/W
MacAdam Lichtquelle	3
Farbwiedergabeindex	90
Leistungsaufnahme*	20 W
Anschluss der Leuchte	DALI
Elektrische Spannung	220-240V
Frequenz	50/60Hz

 CE IP 20

*±10 %

Zum Herunterladen

Montageanleitung



Fotografie



Zubehör



00-00300, N
Seilaufhängung
2000mm



00-00301, N
Seilaufhängung
4000mm



00-00302, N
Seilaufhängung
6000mm



00-00363, K
Kabel 5x1,5 2000mm



00-00364, K
Kabel 5x1,5 4000mm



00-00365, K
Kabel 5x1,5 6000mm



00-00370, B
Deckenkappe
80x80x32mm



00-00370, S
Deckenkappe
80x80x32mm



00-00370, W
Deckenkappe
80x80x32mm



SKB10-1, grey



SKB10-2, black



SKB10-3, white



SKB12-1, grey



SKB12-2, black



SKB12-3, white



XTAK11-1, grey



XTAK142-1, grey



XTAK142-2, black



XTAK142-3, white



XTS41-1, grey



XTS41-2, black



XTS41-3, white



XTSC6100-1, grey



XTSC6100-2, black



XTSC6100-3, white



XTSC611-1, grey



XTSC611-2, black



XTSC611-3, white



XTSC612-1, grey



XTSC612-2, black



XTSC612-3, white



XTSC614-1, grey



XTSC614-2, black



XTSC614-3, white



XTSC6200-1, grey



XTSC6200-2, black



XTSC6200-3, white



XTSC621-1, grey



XTSC621-2, black



XTSC621-3, white



XTSC6300-1, grey



XTSC6300-2, black



XTSC6300-3, white



XTSC634-1, grey



XTSC634-2, black



XTSC634-3, white



XTSC635-1, grey



XTSC635-2, black

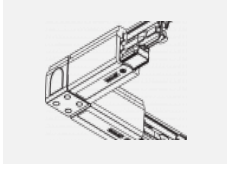

XTSC635-3, white

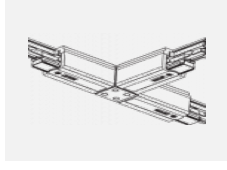

XTSC636-2, black

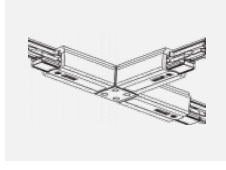

XTSC636-3, white

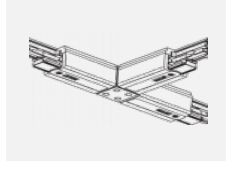

XTSC637-1, grey

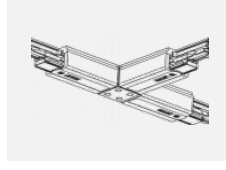

XTSC637-2, black

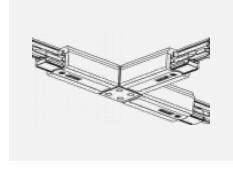

XTSC637-3, white



XTSC638-1, grey



XTSC638-2, black



XTSC638-3, white



XTSC639-1, grey



XTSC639-2, black



XTSC639-3, white



XTSC640-1, grey



XTSC640-2, black



XTSC640-3, white



XTSC6400-1, grey



XTSC6400-2, black



XTSC6400-3, white



XTSCF6100-1, grey



XTSCF6100-2, black



XTSCF6100-3, white



XTSCF6200-1, grey



XTSCF6200-2, black



XTSCF6200-3, white



XTSCF6300-1, grey



XTSCF6300-2, black



XTSCF6300-3, white



XTSCF6400-1, grey



XTSCF6400-2, black



XTSCF6400-3, white



XTSV12-1, grey