



Leuchte

Drob-T

177-600W-10GGE/930, S



Die Form der schwenkbaren dimmbaren Trackleuchte erinnert ein wenig an OldtimerScheinwerfer. Sie enthält leuchtstarke LEDs mit einer Farbwiedergabe von $R_a > 80$ oder $R_a > 90$, einen transparenten Plexiglas- oder satinierten Diffusor. Die Leuchten verwenden Adapter für 3ph-Schienen Global Track. Aufgrund ihres minimalistischen Designs haben sie geringere Lichtströme, und eignen sich daher besser für kleinere Geschäfte mit niedrigeren Decken, wie Drogerien oder Apotheken. Sie können aber auch in Bars oder weniger formellen Empfangsbereichen zum Einsatz kommen.

Technische Zeichnung

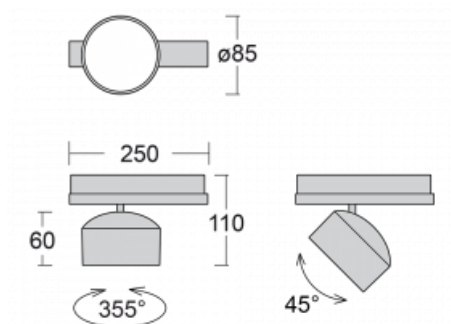

Typ der Montage	Schienenleuchten
Typ der Ausstrahlung	Direkte
Form der Leuchte	Rundleuchte
Farbe der Leuchte	Silber
Material	Aluminium
Lebensdauer	L80/B20 50 000 Stunden
Garantie	5 years
Beschreibung der Leuchte	Schienenleuchte
Abmessungen	ø 85 mm × 110 mm
Gewicht	0.45 kg
Lichtquelle	LED MODUL
Art der Optik	Reflektor
Lichtstrom*	1900 lm
Farbtemperatur	3000 K Warm weiss
Leuchtwirkungsgrad	114 lm/W
Farbwiedergabeindex	90
Abstrahlwinkel	52°
UGR max. X=4H Y=8H, $\rho=70,50,20$	19.4

Kurve



Leistungsaufnahme* 16.7 W

Anschluss der Leuchte ON/OFF

Elektrische Spannung 220-240V

Frequenz 50/60Hz

☐ CE IP 20

*±10 %

Zum Herunterladen

Montageanleitung



Fotografie



Zubehör

00-00300, N
 Seilaufhängung
 2000mm

00-00301, N
 Seilaufhängung
 4000mm

00-00302, N
 Seilaufhängung
 6000mm

00-00363, K
 Kabel 5x1,5 2000mm

00-00364, K
 Kabel 5x1,5 4000mm

00-00365, K
 Kabel 5x1,5 6000mm

00-00370, B
 Deckenkappe
 80x80x32mm

00-00370, S
 Deckenkappe
 80x80x32mm

00-00370, W
 Deckenkappe
 80x80x32mm

SKB10-1, grey

SKB10-2, black

SKB10-3, white

SKB12-1, grey

SKB12-2, black

SKB12-3, white

XTAK11-1, grey

XTAK142-1, grey

XTAK142-2, black

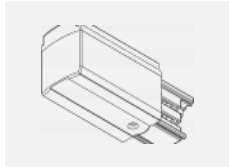
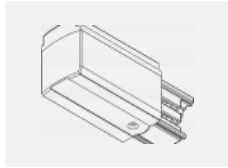
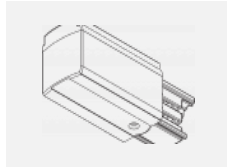
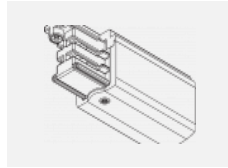
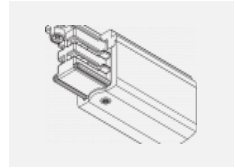
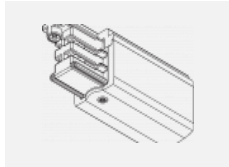
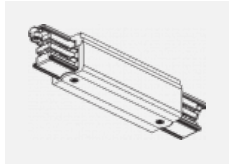
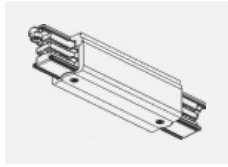
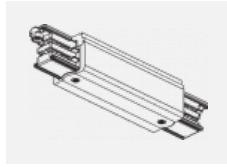
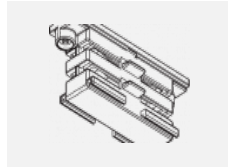
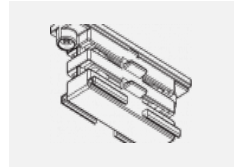
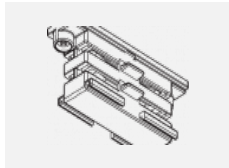
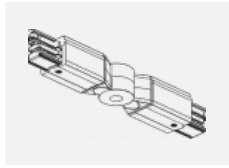
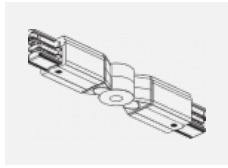
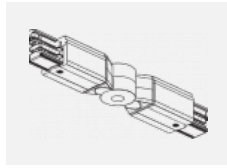
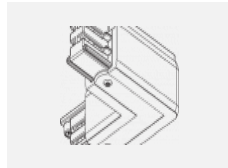
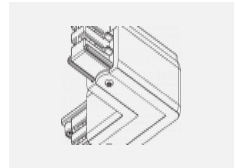
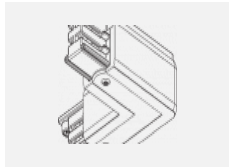
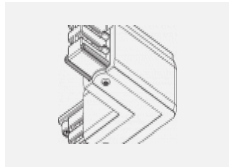
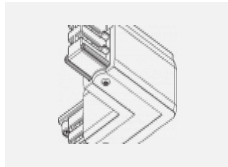
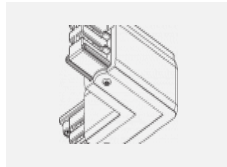
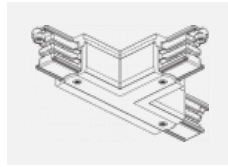
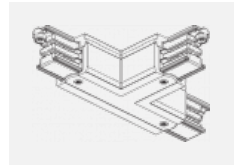
XTAK142-3, white

XTS11-1, grey

XTS11-2, black

XTS11-3, white

XTS12-1, grey

XTS12-2, black

XTS12-3, white

XTS14-1, grey

XTS14-2, black

XTS14-3, white

XTS21-1, grey

XTS21-2, black

XTS21-3, white

XTS24-1, grey

XTS24-2, black

XTS24-3, white

XTS34-1, grey

XTS34-2, black

XTS34-3, white

XTS35-1, grey

XTS35-2, black

XTS35-3, white

XTS36-1, grey

XTS36-2, black



XTS36-3, white



XTS37-1, grey



XTS37-2, black



XTS37-3, white



XTS38-1, grey



XTS38-2, black



XTS38-3, white



XTS39-1, grey



XTS39-2, black



XTS39-3, white



XTS40-1, grey



XTS40-2, black



XTS40-3, white



XTS41-1, grey



XTS41-2, black



XTS41-3, white



XTS4100-1, grey



XTS4100-2, black



XTS4100-3, white



XTS4200-1, grey



XTS4200-2, black



XTS4200-3, white



XTS4300-1, grey



XTS4300-2, black



XTS4300-3, white



XTS4400-1, grey



XTS4400-2, black



XTS4400-3, white



XTSF4100-1, grey



XTSF4100-2, black



XTSF4100-3, white



XTSF4200-1, grey



XTSF4200-2, black



XTSF4200-3, white



XTSF4300-1, grey



XTSF4300-2, black



XTSF4300-3, white



XTSF4400-1, grey



XTSF4400-2, black



XTSF4400-3, white



XTSV12-1, grey