



## Leuchte

# Drob-T

177-600U-10GGD/840, B



Die Form der schwenkbaren dimmbaren Trackleuchte erinnert ein wenig an OldtimerScheinwerfer. Sie enthält leuchtstarke LEDs mit einer Farbwiedergabe von  $R_a > 80$  oder  $R_a > 90$ , einen transparenten Plexiglas- oder satinierten Diffusor. Die Leuchten verwenden Adapter für 3ph-Schienen Global Track. Aufgrund ihres minimalistischen Designs haben sie geringere Lichtströme, und eignen sich daher besser für kleinere Geschäfte mit niedrigeren Decken, wie Drogerien oder Apotheken. Sie können aber auch in Bars oder weniger formellen Empfangsbereichen zum Einsatz kommen.

## Technische Zeichnung

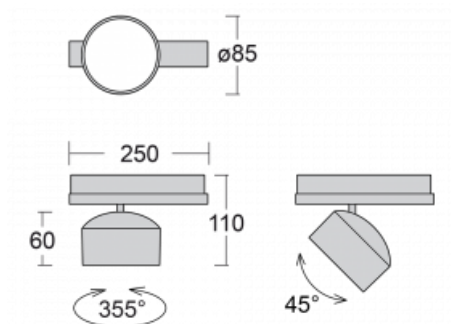

Typ der Montage	Schienenleuchten
Typ der Ausstrahlung	Direkte
Form der Leuchte	Rundleuchte
Farbe der Leuchte	Schwarz
Material	Aluminium
Lebensdauer	L80/B20 50 000 Stunden
Garantie	5 years
Beschreibung der Leuchte	Schienenleuchte
Abmessungen	ø 85 mm × 110 mm
Gewicht	0.5 kg
Lichtquelle	LED MODUL
Art der Optik	Reflektor
Lichtstrom*	2300 lm
Farbtemperatur	4000 K Kalt weiss
Leuchtwirkungsgrad	138 lm/W
MacAdam Lichtquelle	3
Farbwiedergabeindex	80
Abstrahlwinkel	25°
UGR max. X=4H Y=8H, $\rho=70,50,20$	17.5

## Kurve



Leistungsaufnahme\* 16.7 W

Anschluss der Leuchte DALI

Elektrische Spannung 220-240V

Frequenz 50/60Hz

☐ CE IP 20

\* $\pm 10\%$

**Zum Herunterladen**

Montageanleitung



Fotografie



**Zubehör**

**00-00300, N**  
 Seilabhängung  
 2000mm

**00-00301, N**  
 Seilabhängung  
 4000mm

**00-00302, N**  
 Seilabhängung  
 6000mm

**00-00363, K**  
 Kabel 5x1,5 2000mm

**00-00364, K**  
 Kabel 5x1,5 4000mm

**00-00365, K**  
 Kabel 5x1,5 6000mm

**00-00370, B**  
 Deckenkappe  
 80x80x32mm

**00-00370, S**  
 Deckenkappe  
 80x80x32mm

**00-00370, W**  
 Deckenkappe  
 80x80x32mm

**SKB10-1, grey**

**SKB10-2, black**

**SKB10-3, white**

**SKB12-1, grey**

**SKB12-2, black**

**SKB12-3, white**

**XTAK11-1, grey**

**XTAK142-1, grey**

**XTAK142-2, black**

**XTAK142-3, white**

**XTS41-1, grey**

**XTS41-2, black**

**XTS41-3, white**

**XTSC6100-1, grey**

**XTSC6100-2, black**

**XTSC6100-3, white**

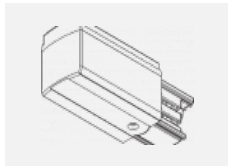
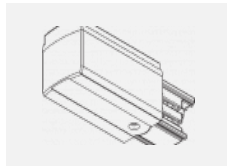
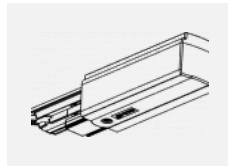
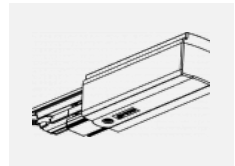
**XTSC611-1, grey**

**XTSC611-2, black**

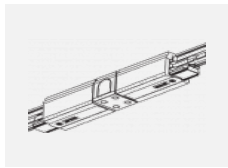
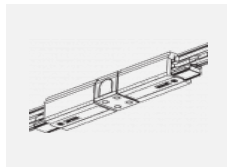
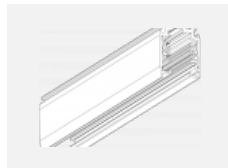
**XTSC611-3, white**

**XTSC612-1, grey**

**XTSC612-2, black**

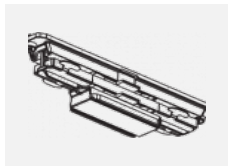
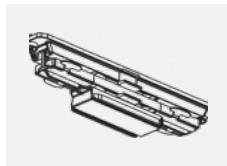
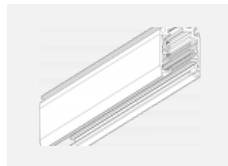
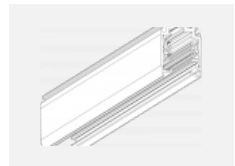
**XTSC612-3, white**

**XTSC614-1, grey**

**XTSC614-2, black**

**XTSC614-3, white**

**XTSC6200-1, grey**

**XTSC6200-2, black**

**XTSC6200-3, white**

**XTSC621-1, grey**

**XTSC621-2, black**

**XTSC621-3, white**

**XTSC6300-1, grey**

**XTSC6300-2, black**



XTSC6300-3, white



XTSC634-1, grey



XTSC634-2, black



XTSC634-3, white



XTSC635-1, grey



XTSC635-2, black



XTSC635-3, white



XTSC636-2, black



XTSC636-3, white



XTSC637-1, grey



XTSC637-2, black



XTSC637-3, white



XTSC638-1, grey



XTSC638-2, black



XTSC638-3, white



XTSC639-1, grey



XTSC639-2, black



XTSC639-3, white



XTSC640-1, grey



XTSC640-2, black



XTSC640-3, white



XTSC6400-1, grey



XTSC6400-2, black

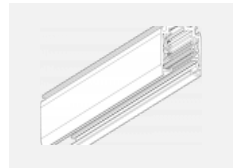

XTSC6400-3, white



XTSCF6100-1, grey



XTSCF6100-2, black



XTSCF6100-3, white



XTSCF6200-1, grey



XTSCF6200-2, black



XTSCF6200-3, white



XTSCF6300-1, grey



XTSCF6300-2, black



XTSCF6300-3, white



XTSCF6400-1, grey



XTSCF6400-2, black

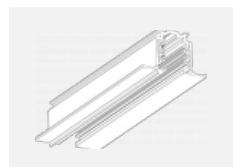

XTSCF6400-3, white



XTSV12-1, grey