



Leuchte

Drob-T

177-600F-10GGD/940, W



Die Form der schwenkbaren dimmbaren Trackleuchte erinnert ein wenig an OldtimerScheinwerfer. Sie enthält leuchtstarke LEDs mit einer Farbwiedergabe von $R_a > 80$ oder $R_a > 90$, einen transparenten Plexiglas- oder satinierten Diffusor. Die Leuchten verwenden Adapter für 3ph-Schienen Global Track. Aufgrund ihres minimalistischen Designs haben sie geringere Lichtströme, und eignen sich daher besser für kleinere Geschäfte mit niedrigeren Decken, wie Drogerien oder Apotheken. Sie können aber auch in Bars oder weniger formellen Empfangsbereichen zum Einsatz kommen.

Technische Zeichnung

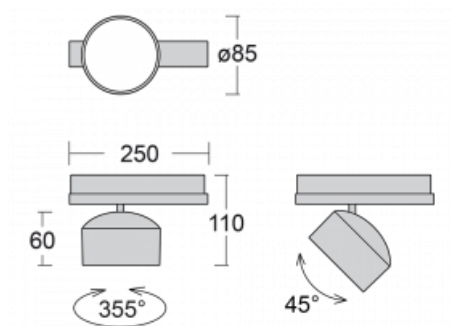

Typ der Montage	Schienenleuchten
Typ der Ausstrahlung	Direkte
Form der Leuchte	Rundleuchte
Farbe der Leuchte	Weiss
Material	Aluminium
Lebensdauer	L80/B20 50 000 Stunden
Garantie	60 Monate
Beschreibung der Leuchte	Schienenleuchte
Abmessungen	ø 85 mm × 110 mm
Gewicht	0.5 kg
Lichtquelle	LED MODUL
Art der Optik	Reflektor
Lichtstrom	2000 lm ± 10 %
Farbtemperatur	4000 K Kalt weiss
Leuchtwirkungsgrad	120 lm/W
MacAdam Lichtquelle	3
Farbwiedergabeindex	90
Abstrahlwinkel	32°
UGR max. X=4H Y=8H, $\rho=70,50,20$	16.9

Kurve

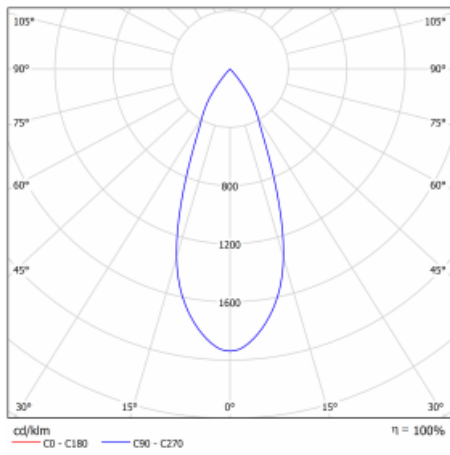

Leistungsaufnahme 16.7 W ± 10 %

Anschluss der Leuchte DALI dimmbar

Elektrische Spannung 220-240V

Frequenz 50/60Hz

☐ CE IP 20

Zum Herunterladen

Montageanleitung



Fotografie



Zubehör

00-00300, N
 Seilaufhängung
 2000mm

00-00301, N
 Seilaufhängung
 4000mm

00-00302, N
 Seilaufhängung
 6000mm

00-00363, K
 Kabel 5x1,5 2000mm

00-00364, K
 Kabel 5x1,5 4000mm

00-00365, K
 Kabel 5x1,5 6000mm

00-00370, B
 Deckenkappe
 80x80x32mm

00-00370, S
 Deckenkappe
 80x80x32mm

00-00370, W
 Deckenkappe
 80x80x32mm

SKB10-1, grey

SKB10-2, black

SKB10-3, white

SKB12-1, grey

SKB12-2, black

SKB12-3, white

XTAK11-1, grey

XTAK142-1, grey

XTAK142-2, black

XTAK142-3, white

XTS41-1, grey

XTS41-2, black

XTS41-3, white

XTSC6100-1, grey

XTSC6100-2, black

XTSC6100-3, white

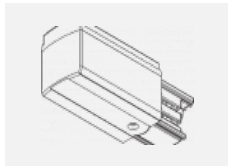
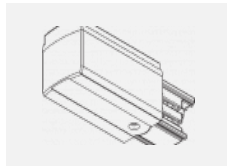
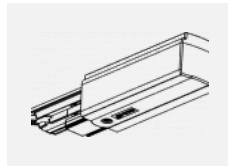
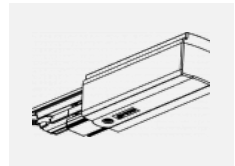
XTSC611-1, grey

XTSC611-2, black

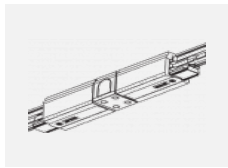
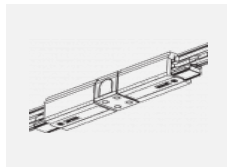
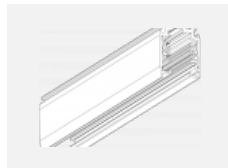
XTSC611-3, white

XTSC612-1, grey

XTSC612-2, black

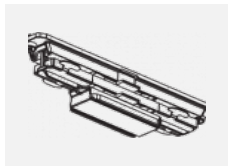
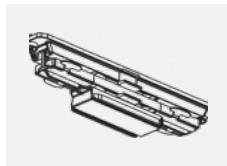
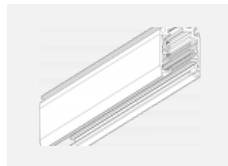
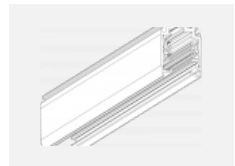
XTSC612-3, white

XTSC614-1, grey

XTSC614-2, black

XTSC614-3, white

XTSC6200-1, grey

XTSC6200-2, black

XTSC6200-3, white

XTSC621-1, grey

XTSC621-2, black

XTSC621-3, white

XTSC6300-1, grey

XTSC6300-2, black



XTSC6300-3, white



XTSC634-1, grey



XTSC634-2, black



XTSC634-3, white



XTSC635-1, grey



XTSC635-2, black



XTSC635-3, white



XTSC636-2, black



XTSC636-3, white



XTSC637-1, grey



XTSC637-2, black

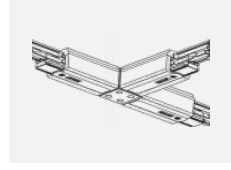

XTSC637-3, white



XTSC638-1, grey



XTSC638-2, black



XTSC638-3, white



XTSC639-1, grey



XTSC639-2, black

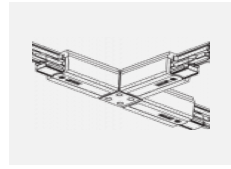

XTSC639-3, white



XTSC640-1, grey



XTSC640-2, black



XTSC640-3, white



XTSC6400-1, grey



XTSC6400-2, black

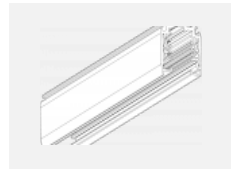

XTSC6400-3, white



XTSCF6100-1, grey



XTSCF6100-2, black



XTSCF6100-3, white



XTSCF6200-1, grey



XTSCF6200-2, black



XTSCF6200-3, white



XTSCF6300-1, grey



XTSCF6300-2, black



XTSCF6300-3, white



XTSCF6400-1, grey



XTSCF6400-2, black



XTSCF6400-3, white



XTSV12-1, grey