

Power of light



Halla

Power of light

About us	4—27	Single luminaires	28—143	Lighting systems	144—195
Power of experience	4	Basi	135	Flumo60-S	146
Power of detail	8	Burbu	88	Flumo100-S	151
Human Centric Lighting	10	Drob	106	Lina45-S	170
Special sources	11	Fini	91	Lina80-S	175
Halla Smart	12	Gatu	138	Lipo35-S	179
Halla Xpress	14	Huge	70	Lipo45-S	183
Designers	16	Ilbi	64	Lipo60-S	186
Awards	17	Ilbi+	141	Lipo80-S	190
Product overview	18	Indi	82	Mila-S	156
Case studies	20	Ineli	33	Rofo-S	194
		Kvado	85	Sant-S	162
		Legio	36	Unda-S	159
		Leira	100	Zuli-S	166
		Lina28	41		
		Lina45	43		
		Lina80	46		
		Lipo28	49		
		Lipo35	52		
		Lipo45	55		
		Lipo45-T	125		
		Lipo60	58		
		Lipo60-T	127		
		Lipo80	61		
		Puri	73		
		Ravo	132		
		Rotao60	76		
		Rotao100	79		
		Rundo	67		
		Sant	38		
		Sant-T	122		
		Shift	103		
		Sineli	97		
		Stan	94		
		Ture	129		
		Vali55	113		
		Vali55-T	109		
		Vali80	118		
		Vali80-T	115		
		Zuli	30		

Power of experience

We are Czech manufacturer and exporter of technical design luminaires.

In Halla, we believe that high-quality lighting provides a better experience of a place whether you are at home, at work, in a restaurant or a gym.

30

Years on the market

50

Countries where Halla lighting is used

105

Employees

3500

Projects for the year 2021



Our story

We started out in a small workshop

We began assembling the first luminaires in a rented cellar in 1992. Today, 30,000 of them are made in a modern production hall. Sometimes, it seems like a light year has passed since the beginning. But our passion for beautiful lights still keeps us captivated.

Obstacles such as commitment to growth

When the economic crisis hit us hard in 2009 and our revenues declined by 41% from one day to the next, we could either give up or adapt. We had to streamline the company, transform the business and marketing strategy and add more passion to our work.

Combining quality and design

In the beginning, technical parameters were our primary focus. An exhibition in Hanover in 1997 opened our eyes and doors to the world of light. We added a unique appearance to the quality and began to develop lighting that combined top performance and a unique design.



Power of detail

Technical Support

Our Technical Support department attends dozens of conferences and training sessions a year. Direct your questions straight to a technician without any go-between.

What can we do for you?

We help create projects from A to Z, we will prepare training and presentations, we provide the technical and photometric data of luminaires, we process technical light calculations.

All support tools in one place on our website.

- BIM BIM objects for ARCHICAD and Revit
- 3D models DWG for AutoCAD, 3DS for 3DS Max, 3DM for Rhino
- DIALux Plug-in
- Eulumdata Fotometric data in format .ldt a .ies for use in RELUX, WILS, AGi32 and other

Contact us: tech.support@halla.cz

Development laboratory

For the development of luminaires thermal and optical measurement is essential and is performed in the development laboratory.

The principal areas of the laboratory are the black room with goniophotometer and integrating sphere and thermal draught-proof chamber. The dropped ceiling for installation and testing of luminaires is also a part of it.

The Halla laboratory has a very low value for the deviation of measurement, which is 4%.



Human Centric Lighting

Human Centric Lighting adapts to circadian, or biological, human cycles. Luminaires adapted to these rhythms work by mimicking natural sunlight.

Lighting on the principle of HCL is applied where people work, learn, and live. Everywhere they need light that helps with everyday activities. The lighting is suitable for working areas, hospitals, schools or retirement homes.



TunableWhite (TW)



Our luminaires feature Tunable White HCL technology.

Basi, Gatu, Huge, Indi, Kvado, Leira, Lina45, Lina45-S, Lina80, Lina80-S, Lipo45, Lipo45-S, Lipo60, Lipo60-S, Lipo80, Lipo80-S, Stan, Sineli, Mila-S, Puri, Ravo, Rotao100, Rotao60, Rundo, Sant, Sant-T, Sant-S, Ture, Zuli and Zuli-S.

Special sources

Eight out of ten customers do their shopping based on feelings. The initial impression decides whether the goods are appealing. Lighting plays an important role in this – a properly lit product attracts attention, making it more appealing for the customer.

Luminaires for retail include LEDs for illuminating specific products and colors.

StrongColour (SC)



RealColour (RC)



RealWhite (RW)



Halla Smart

You can very easily and cleverly control ordinary luminaires and more complex DALI system (for example the whole office building). We offer a wide range of solutions for most of Halla's products. Get a grasp of what is important and needed for you and what all is possible.

The luminaire or the lighting system which is controlled by the movement, daylight or via Bluetooth technology from the smart device.



The advantages of the control of Halla Smart

- Added value of dimming in the form of higher visual comfort
- The flexibility of a lighting solutions
- Remote control, light scenes and the Human Centric Lighting
- By setting dimming, daylight control or motion detection
- The possibility of the integrating lighting into a complex building management
- The possibility of custom setting of control parameters by the customer



More information
www.halla.eu/xpress

Product inquiries and orders
export@halla.cz

Offices

Halla Smart is a very suitable solution for the open space offices, bigger or smaller administration buildings, corridors or receptions and office entrances. It will also find its application in the whole of administration buildings, where it brings significant savings and contribute to the healthy environment.



Households

Halla Smart will enable to create appropriate atmosphere in your living room and achieve the lighting comfort. The use of the smart control also has a positive effect on our health (by using the Human Centric Lighting technology). You can complete the system with a convenient smartphone control.



Public spaces

A halls of shopping centres, communication spaces of galleries and sports grounds or public toilets are typical examples of the use our Halla Smart solution. They are economical and at the same time ecological.



Halla Xpress

The most sought-after luminaires in stock



More information
www.halla.eu/xpress

Product inquiries and orders
export@halla.cz

Long delivery terms? It does not apply to us! We introduce Halla Xpress

As you may have noticed, a number of companies has been dealing with a global lack of components lately which is bothering the world industry. Due to this problem, delivery terms are getting longer and the customers must wait for their goods a number of days, if not weeks.

Therefore, we come up with a novelty – Halla Xpress. We have chosen for you the most sought-after luminaires, including accessories that are available with us in stock.



Designers



Rob van Beek

This world-renowned Dutch designer and architect is dedicated to the lighting designs of the royal Dutch palaces. Rob designed the Tres, Mila, Unda luminaires for us as well as the award-winning Sant.



Serge Cornelissen

You will find perfectly sophisticated proportions and details in his luminaires. Serge has been cooperating with us since 2016 and designed the Vima luminaire.

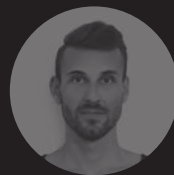

Matúš Opálka

Matúš's luminaires have a minimalist design, innovation and functionality. He is responsible for the Inlio, Ixyo, Indi, Ilbi, Ilbi+ luminaires and has received the Red Dot Design Award 2014 and others.

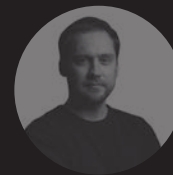

Kryštof Nosál

This talented designer owns Nosál Design studio, where he creates with a simple rule: to offer uncomplicated solutions with a clear idea. The Red Dot Design Award winner enters our ranks with the latest Shift luminaire.













Awards





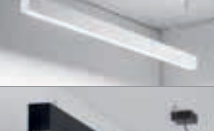

















All our luminaires have LED light sources, which we are constantly innovating and using only those the latest generation with the best parameters.





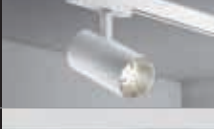

Single luminaires













Zuli		30	Ineli		33
Legio		36	Sant		38
Lina28		41	Lina45		43
Lina80		46	Lipo28		49
Lipo35		52	Lipo45		55
Lipo60		58	Lipo80		61
Ilbi		64			

Rundo		67	Huge		70
Puri		73	Rotao60		76
Rotao100		79	Indi		82
Kvado		85	Burbu		88
Fini		91	Stan		94
Sineli		97	Leira		100

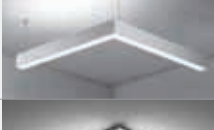
Shift		103	Drob		106
Vali55-T		109	Vali55		113
Vali80-T		115	Vali80		118
Sant-T		122	Lipo45-T		125
Lipo60-T		127			

Ture		129	Ravo		132
Basi		135	Gatu		138
Ilbi+		141			

Lighting systems

Flumo60-S		146	Flumo100-S		151
Mila-S		156	Unda-S		159
Sant-S		162	Zuli-S		166
Lina45-S		170	Lina80-S		175
Lipo35-S		179	Lipo45-S		183
Lipo60-S		186	Lipo80-S		190
Rofo-S		194			



Case study

Puskás Aréna

Photographer: Filip Györe

 Huge, Lipo60

After two years of reconstructing the Puskás Arena, Europe now has a new modern venue to host sports and cultural events. The construction of the stadium was financed by the Hungarian government and cost EUR 610 million, making it one of the most expensive stadiums on the continent. The football stadium of the Hungarian Football Federation with a capacity of more than 67,000 seats meets all the requirements of UEFA and FIFA, and therefore hosted UEFA Euro in 2021.

The construction of the Budapest Puskás Arena is characterized by two distinctive features – a concrete mosaic on the outside, while on the inside an important role was played by the lighting, including our luminaires.



“The Halla company offered good quality at a reasonable price, which was very important for us, because we used about 7 km of Lipo60 linear luminaires to create a pattern of fish bones in the entire VIP zone. A great advantage was also their easy installation,” says Istvan Vonnák from West Hungaria Bau explaining the selection of the supplier. Halla’s products were also used in other parts of the stadium to enhance the dynamics of the interior. 1800 pieces of the Huge circular luminaire have been installed in the skyboxes and lounges in the VIP zone, but also in the foyer on the ground floor and in the hall, from where the players enter the grass field.





The architects chose our Flumo100-S luminaires, whose unique flexibility made it possible to accurately match the design of the running tracks on the floor and, together with other luminaires (Vali80-T, Ture and Lipo60), emphasize the company's area of operation and the modern design of the offices. The architects had very specific ideas of what they wanted and we tried to support their sense of precision, so at their request, we supplied luminaires with black instead of transparent cables.

Case study

Livesport

Photographer: Jiří Lízler

 Ture, Lipo60, Flumo100-S

Every modern company has the ambition to offer their employees a comfortable and motivating working environment. A great example are the Livesport offices with their unique design with a sporty vibe. The management clearly described their requirements including separate offices, shared areas, soft surfaces and neutral colours to support work concentration and performance. This difficult task was entrusted to the architects of Studio Reaktor, whose design excels in both the attractiveness and functional arrangement of the working environment and the clear effort to capture movement in space.





Case study

Dancing Café

Photographer: Ester Havlová

 Flumo100-S

The Dancing House, designed by the world-class architect Frank O. Gehry, has a new café. The gradually changing purpose of the building (also called Ginger and Fred) from the originally administrative building into a hotel with a restaurant and a bar on the upper floors, as well as the growing number of visitors to the building, made it necessary to change the ground floor as well.



The investor's requirement was not only to design a new café, but also to modify the existing layout and to design a new reception desk. ARTIKUL architects approached this difficult task with maximum respect for the original design as well as the architectural principles of the building. That's why they chose our Flumo-S luminaire, which navigates the visitor from the entrance through the entire space. It enhances the dynamics of the space and is a significant feature that attracts attention even from the street. You still feel very cosy while drinking your coffee and there is a pleasant atmosphere in the café.





Case study

PKV

Photographer: Pinarto

 Mila-S, Ture, Flumo100-S, Vali80, Rotao100

When PKV Build Company was moving into new larger premises, the main goal was to create a place that would reflect the company's culture and, at the same time, provide enough privacy, great working environment as well as the opportunity to relax.

"The combination of technologies, greenery, architecture and perfect workmanship gives us the opportunity to implement our ideas and thus provide our clients with high-quality services. In the offices, we can also show them the technologies that we actually recommend to them," explains Jiří Pech, the company's managing director. The company had a sophisticated lighting system installed in their offices without a single physical switch.



The lights are either self-regulating depending on how much sunlight comes from the outside, or they can be controlled via an application. At the same time, the so-called biophilic design was used, which has a beneficial effect on the overall mental well-being of the employees and on their concentration. The environment, where the walls are covered with moss and the corridors lined with houseplants, is simply more natural and pleasant.

The lights are either self-regulating depending on how much sunlight comes from the outside, or they can be controlled via an application. At the same time, the so-called biophilic design was used, which has a beneficial effect on the overall mental well-being of the employees and on their concentration. The environment, where the walls are covered with moss and the corridors lined with houseplants, is simply more natural and pleasant.



Single luminaires

www.halla.eu/zuli

Single luminaires

Zuli

Do you still remember the flickering and buzzing lights in the school classrooms? Fortunately, they are gone for good. Zuli pendant and surface LED luminaires provide visual comfort in classrooms, offices and hospitals without any of these problems. The luminaires feature direct or direct-indirect distribution of light. You can choose from several lengths and in terms of optics there is a choice of microprismatic system, louver, opal diffuser or asymmetric reflector.



Installation



Light distribution



Colour



Dimensions
(l x w x h mm)



590 x 125 x 50
865 x 125 x 50



1145 x 125 x 50
1425 x 125 x 50
1705 x 125 x 50
2265 x 125 x 50



d +100 mm

Material
aluminium
plastic

Optical system

Indirect component - opal diffuser
polished/matt parabolic louvre
microprismatic optical system
asymmetrical reflector
opal diffuser

Halla Smart

control via Bluetooth
sensor

Electrical connection

ON/OFF
DALI
DALI DT8 (TunableWhite)
emergency 1h
emergency 3h

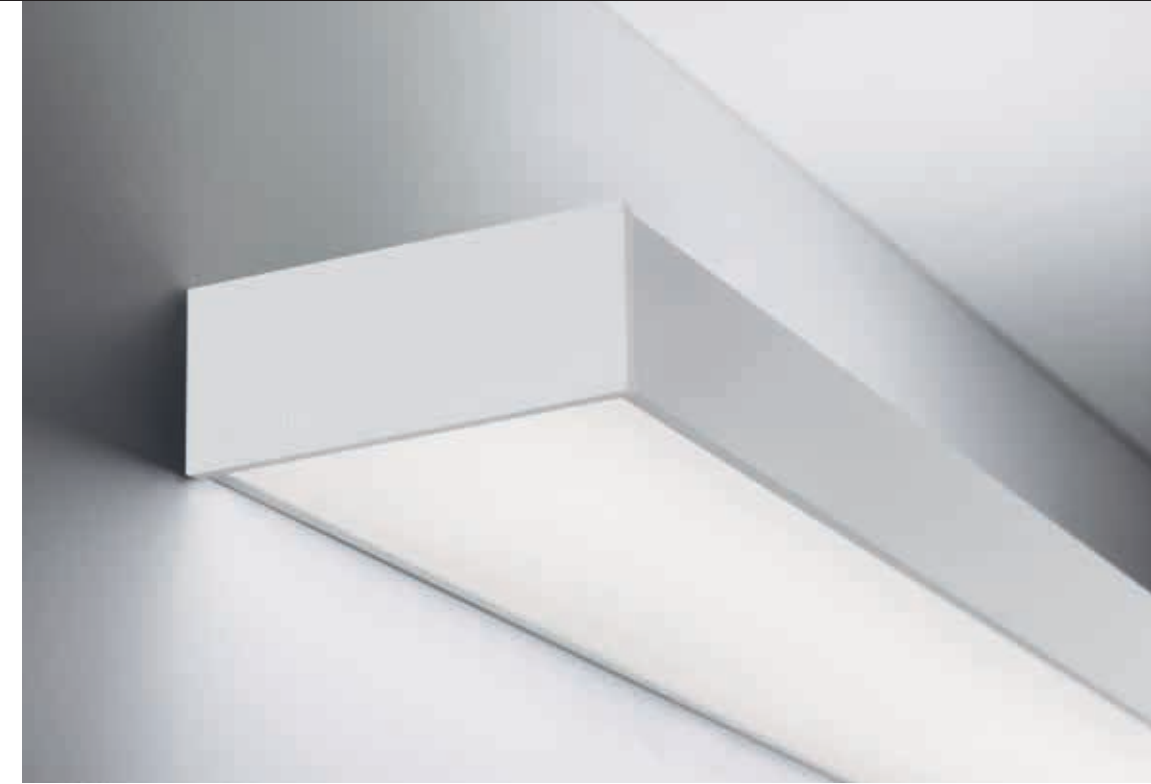



www.halla.eu/ineli

Single luminaires

Ineli

Pendant luminaire with a transparent optical system, two luminous fluxes and a height of only 27 mm, which is best used in an office. The Ineli luminaire with direct-indirect distribution of light will catch your eye with its low aluminium profile, forming the frame of the lighting area. Thanks to its superior technical features, it can also make every meeting room, informal café or relaxation zone more pleasant. Thanks to the fact that the power is supplied via suspension wires, there is no need for a power cable. The luminaire can be hung horizontally or at any angle, which gives the space an impression of uniqueness and airiness. In addition, it can be perfectly combined with the free-standing version, i.e. the Sineli luminaire.

UGR < 19





Installation



Light distribution



Colour



Dimensions

(l x w x h mm)

594 x 594 x 27

1194 x 294 x 27

Material
aluminium

Optical system
microprismatic optical system

Electrical connection
ON/OFF
DALI

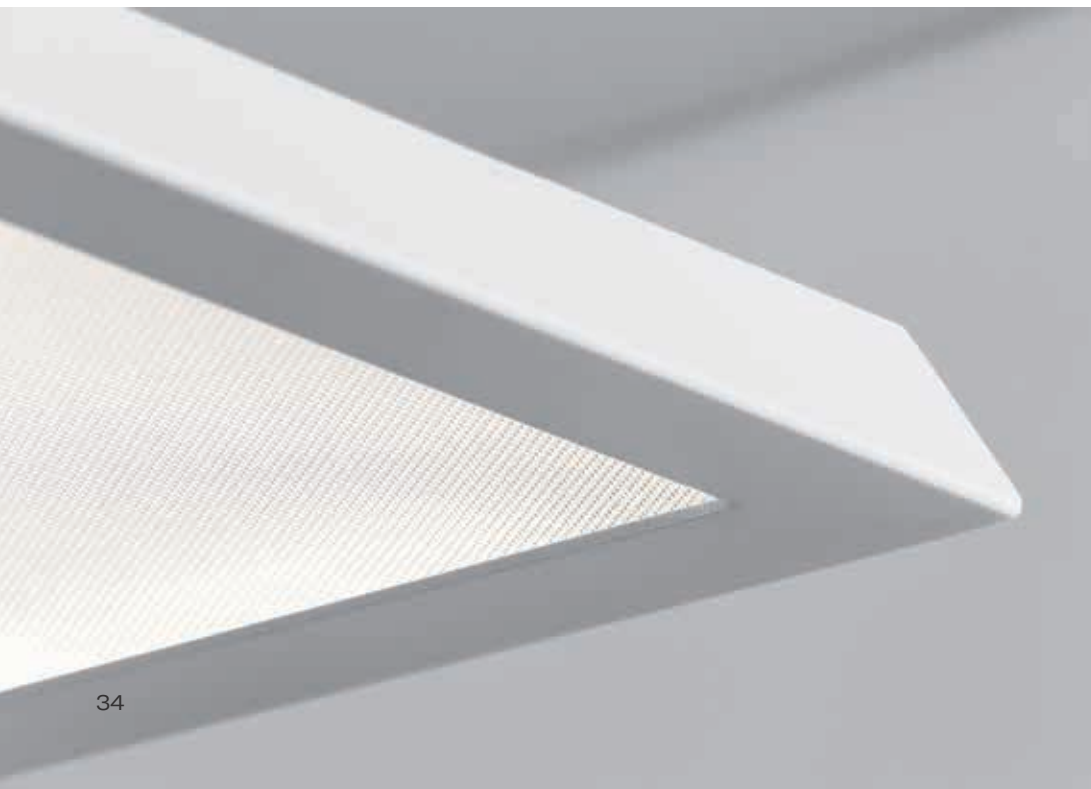

www.halla.eu/legio

Single luminaires

Legio

We have designed the Legio luminaire in cooperation with Belgian designer Serge Cornelissen, who came up with an interesting idea of two identical luminaires in two different coats. These consist of an outer aluminium profile painted in white, black or silver and an aluminium profile painted in a special white colour. Its shape variations evoke basic geometric shapes that will make us reminisce about geometry lessons in the third grade of our primary school, where these luminaires definitely belong and can be used as an admissible cheat sheet. The variety of shapes and, last but not least, the excellent parameters of 130 lm/W and UGR <19 make the luminaires mainly suitable for office or social spaces, but they can also be used, for example, in commercial spaces or households.



Design: Serge Cornelissen

Installation



Light distribution



Colour



Dimensions

(l x w x h mm)

1130 x 170 x 40

1410 x 170 x 40

1690 x 170 x 40

2250 x 170 x 40



d +100 mm

Material
aluminium
plastic

Optical system

Indirect component – opal diffuser
microprismatic optical system
opal diffuser

Halla Smart

control via Bluetooth
sensor

Electrical connection

ON/OFF

DALI

DALI DT8 (TunableWhite)

emergency 1h

emergency 3h

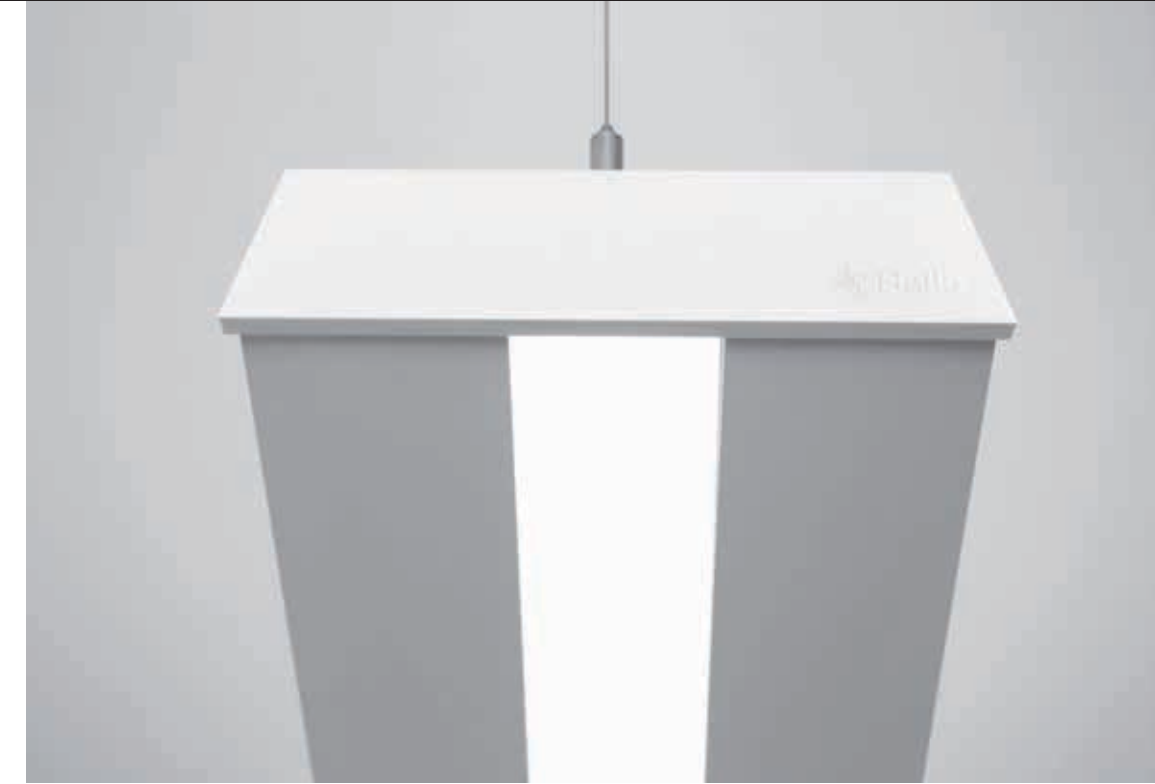

www.halla.eu/sant

Single luminaires

Sant



LIGHTING
DESIGN
AWARDS 2015



reddot design award
winner 2015



German
Design Award
2015

The Dutch designer Rob van Beek gave this linear luminaire with an opal diffuser a world-class look. In the Czech Republic, Sant has specially been made for LED sources and Human Centric Lighting technology. This means that the light changes its intensity and colour temperature according to circadian rhythms. People thus feel natural in a closed space because the lighting simulates daylight. If you are looking for single linear luminaires for an office, school or hospital, you have just found them.

Design: Rob van Beek

Installation



Light distribution



Colour



Dimensions (l × w × h mm)

568 × 66 × 92

848 × 66 × 92

1128 × 66 × 92

1408 × 66 × 92

1688 × 66 × 92

1968 × 66 × 92

2248 × 66 × 92

For other dimensions
or shapes Sant-S

162

Material
aluminium
plastic

Optical system
opal diffuser

Halla Smart
control via Bluetooth

Electrical connection
ON/OFF
DALI
DALI DT8 (TunableWhite)
emergency 1h
emergency 3h





www.halla.eu/lina28

Single luminaires

Lina28

The Lina28 luminaire with direct-indirect distribution of light is the thinnest linear luminaire in our product range. It is made of high-quality aluminium profile and the luminaire also includes an electronic ballast, which does not need to be placed outside the luminaire, as is usual with such thin profiles. The luminaire features an integrated optical louver, which ensures low values of the UGR parameter, or, as an alternative option, an opal diffuser made of PMMA material which guarantees a premium UV stability. All of this makes the pendant luminaire suitable for offices, corridors, social spaces or whenever a minimalist design is required.

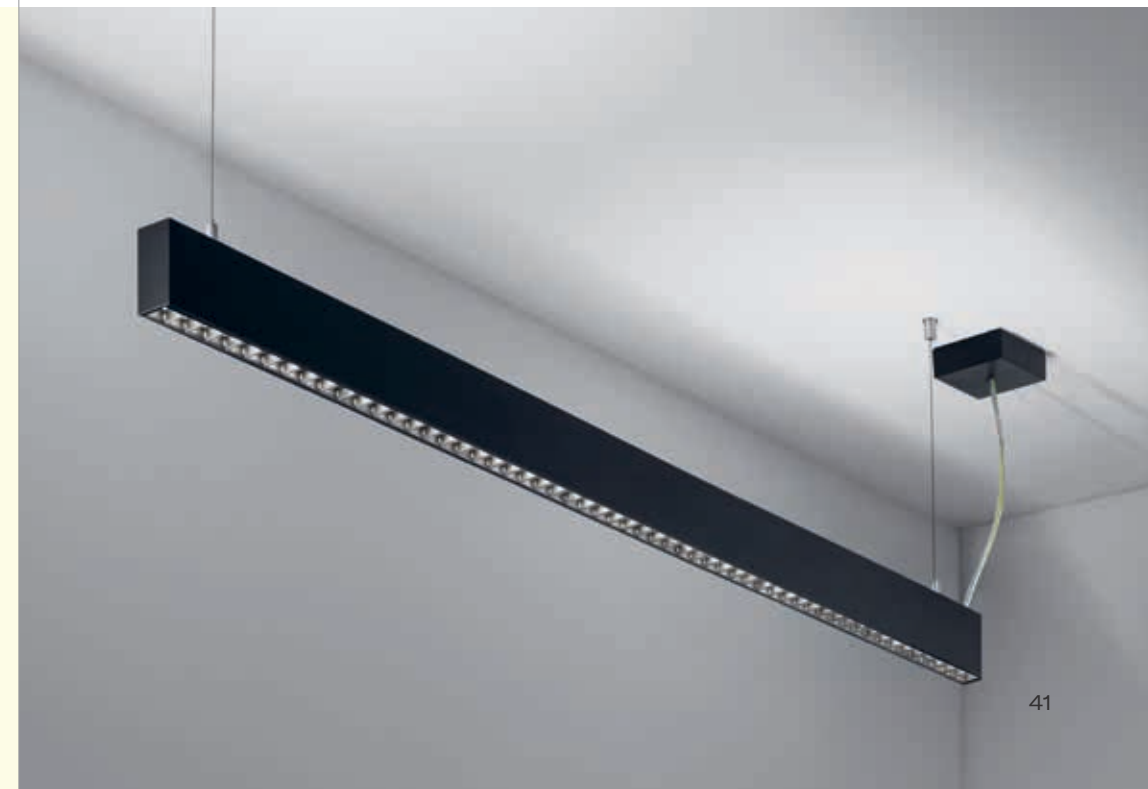



www.halla.eu/lina45

Single luminaires
Lina45

The Lina45 luminaires with direct-indirect distribution of light are made of aluminium profile and come in a pendant version. The lower part of the luminaire contains optical components and the upper part contains electrical components as well as the indirect part of the LED light sources. You can buy a version with an optical lens in combination with a plastic louvre, which makes the luminaires best suited for offices or spaces with a similarly high demand for an anti-glare solution. We also offer a version with an opal cover or microprismatic optics. You can also choose whether you prefer metal end caps or plastic ones without visible screws.

Installation



Light distribution



Colour



Dimensions
(l x w x h mm)

- 1131 x 28 x 61
- 1412 x 28 x 61
- 1692 x 28 x 61
- 1973 x 28 x 61
- 2253 x 28 x 61



d +100 mm

Material

aluminium
plastic

Optical system

Indirect component – opal diffuser
plastic louvre with low UGR
diffusor

Halla Smart

control via Bluetooth
sensor

Electrical connection

ON/OFF
DALI

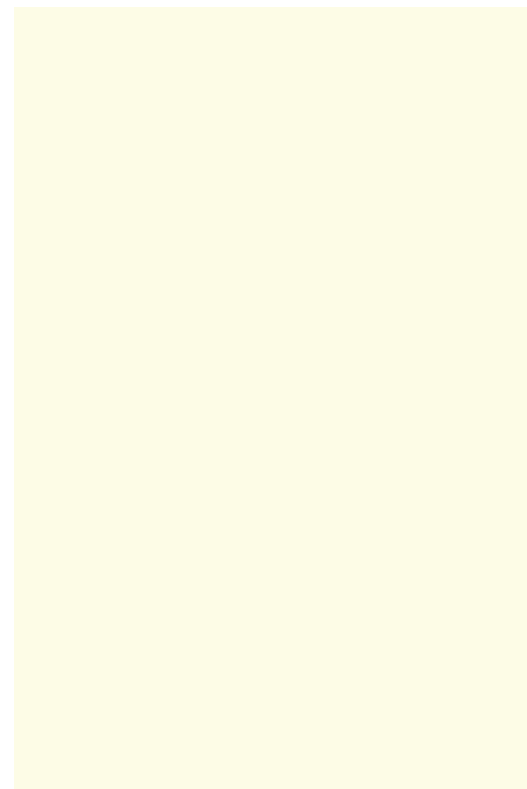

Installation



Light distribution



Colour



Dimensions

(l x w x h mm)

1131 x 47 x 59

1412 x 47 x 59

1692 x 47 x 59

1973 x 47 x 59

2253 x 47 x 59



d +100 mm

For other dimensions or shapes Lina45-S

170



Material
aluminium
plastic

Optical system
Indirect component - opal diffuser
plastic louver with low UGR
microprismatic optical system
opal diffuser

Halla Smart
control via Bluetooth
sensor

Electrical connection
ON/OFF
DALI
DALI DT8 (TunableWhite)
emergency 1h
emergency 3h



www.halla.eu/lina80

Single luminaires
Lina80

Lina80 luminaires with a practical L-Click system feature an elegant and classic design of linear luminaires with excellent lighting parameters, available in both pendant and wall versions, allowing them to fit into almost any space. Lina80 lighting is the right solution for commercial, social or cultural spaces as well as households and restaurants. With Tunable White technology, you set the colour temperature according to the time of day. The luminaire thus provides optimal light to help you better focus and concentrate on your work.



Installation



Light distribution



Colour



Dimensions
(l x w x h mm)

566 x 80 x 93

847 x 80 x 93

1127 x 80 x 93

1408 x 80 x 93

1688 x 80 x 93

1969 x 80 x 93

2249 x 80 x 93



d +100 mm

For other dimensions
or shapes Lina80-S

175

Material

aluminium

plastic

Optical system

Indirect component – opal diffusor

polished/matte parabolic louver

microprism with low UGR

microprismatic optical system

opal diffusor

Halla Smart

control via Bluetooth

sensor

Electrical connection

ON/OFF

DALI

DALI DT8 (TunableWhite)

emergency 1h

emergency 3h





www.halla.eu/lipo28

Single luminaires

Lipo28



The Lipo28 luminaire with direct distribution of light is the thinnest linear luminaire in our product range. It is made of high-quality aluminium profile of various lengths and the luminaire also includes an electronic ballast, which does not need to be placed outside the luminaire, as is usual with such thin profiles. The luminaire features an integrated optical louver, which ensures low values of the UGR parameter, or, as an alternative option, an opal diffuser made of PMMA material which guarantees a premium UV stability. All of this makes the pendant luminaire suitable for offices, corridors, social spaces or whenever a minimalist design is required.



Installation



Light distribution



Colour



Dimensions
(l x w x h mm)

- 1131 x 28 x 61
- 1412 x 28 x 61
- 1692 x 28 x 61
- 1973 x 28 x 61
- 2253 x 28 x 61

Material
aluminium
plastic

Optical system
plastic louver with low UGR
opal diffuser

Halla Smart
control via Bluetooth
sensor

Electrical connection
ON/OFF
DALI

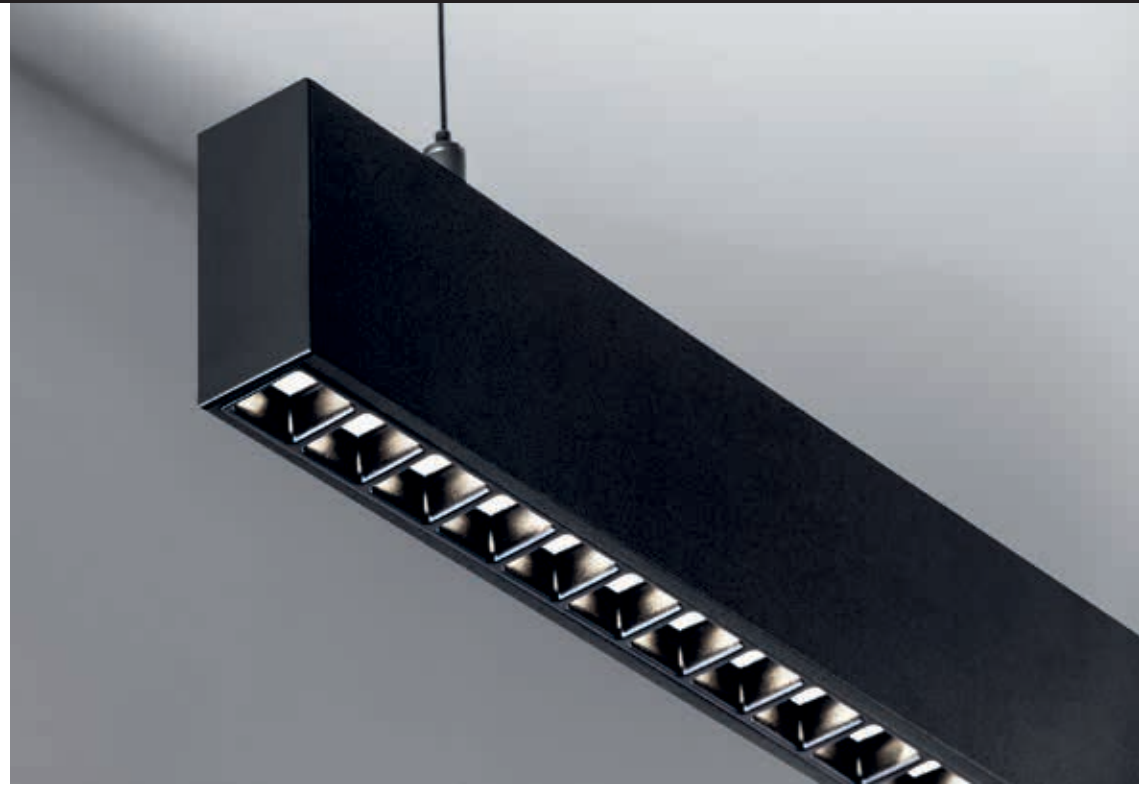

www.halla.eu/lipo35

Single luminaires

Lipo35

The linear luminaires of the Lipo35 family represent one of the thinnest profiles in our product range, while you can choose from several different lengths. The luminaires with direct distribution of light are available in the pendant, surface and recessed versions. Thanks to the option to extend and retract the opal diffuser, you can find the ideal combination of lights for a specific interior according to your needs. Thanks to this variability, Lipo35 can be used in virtually all areas, but especially in the social, public and commercial ones. Luminaires with an extended diffuser diffuse their light into a significantly larger area thus helping to soften the entire interior.

Installation



Light distribution



Colour



Dimensions (l x w x h mm)



- 566 x 37 x 60 (75)
- 847 x 37 x 60 (75)
- 1127 x 37 x 60 (75)
- 1408 x 37 x 60 (75)
- 1688 x 37 x 60 (75)
- 1969 x 37 x 60 (75)
- 2249 x 37 x 60 (75)
- 2810 x 37 x 60 (75)
- 3371 x 37 x 60 (75)
- 4493 x 37 x 60 (75)



- 581 x 54 x 95
- 862 x 54 x 95
- 1142 x 54 x 95
- 1423 x 54 x 95
- 1703 x 54 x 95
- 1984 x 54 x 95
- 2264 x 54 x 95
- 2825 x 54 x 95
- 3386 x 54 x 95
- 4508 x 54 x 95

For other dimensions or shapes Lipo35-S

179



Material
aluminium
plastic

Optical system
opal diffusor

Halla Smart
control via Bluetooth

Electrical connection

ON/OFF
DALI
emergency 1h
emergency 3h



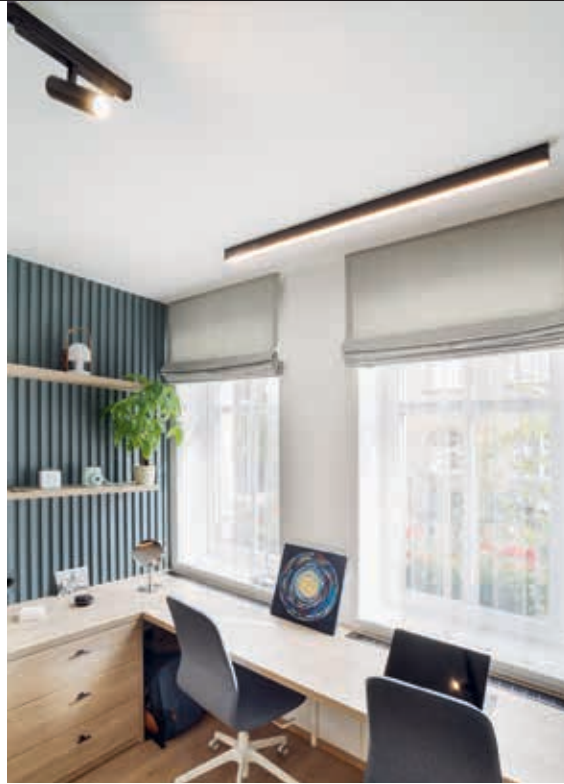

www.halla.eu/lipo45

Single luminaires

Lipo45

Lipo45 luminaires with direct distribution of light are made of an aluminium profile and are available in surface and pendant versions. You can buy a version with an optical lens in combination with a plastic louver, which makes the luminaires best suited for offices or spaces with a similarly high demand for an anti-glare solution. We also offer a version with an opal cover or microprismatic optics. You can also choose whether you prefer metal end caps or plastic ones without visible screws.

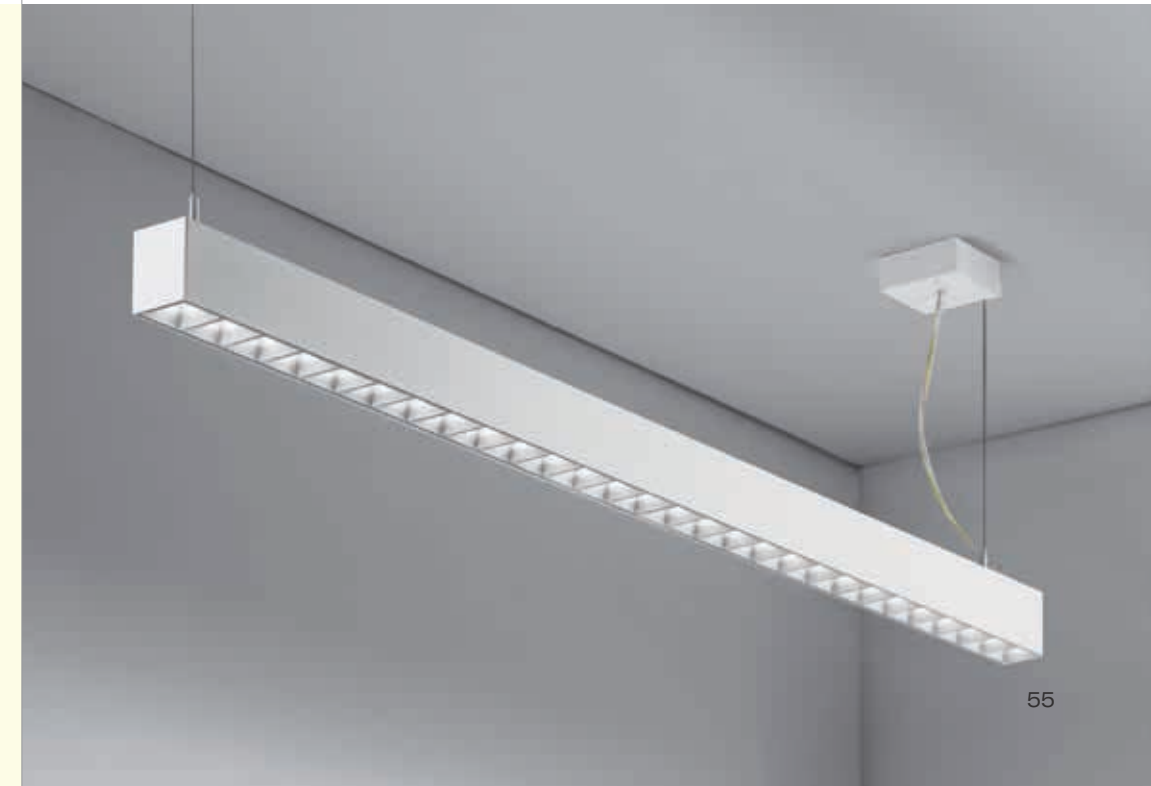

Installation



Light distribution



Colour



Dimensions
(l x w x h mm)

- 1131 x 47 x 59
- 1412 x 47 x 59
- 1692 x 47 x 59
- 1973 x 47 x 59
- 2253 x 47 x 59



d +100 mm

For other dimensions
or shapes Lipo45-S

183



Material
aluminium
plastic

Optical system
plastic louver with low UGR
opal diffuser
microprismatic optical system

Halla Smart
control via Bluetooth
sensor

Electrical connection
ON/OFF
DALI
DALI DT8 (TunableWhite)
emergency 1h
emergency 3h



www.halla.eu/lipo60

Single luminaires

Lipo60

One of the features you will appreciate on Lipo60 luminaires is the L-Click system, which facilitates the installation as the module clicks easily into the aluminium profile without the need for tools. This solution also prevents the direct contact with the LED technology, which makes its service life significantly longer. In addition to perfect performance, the luminaire also offers a great price. It can be used in commercial, social and public spaces.

Installation



Light distribution



Colour



Dimensions (l x w x h mm)



566 x 57 x 67
847 x 57 x 67
1127 x 57 x 67
1408 x 57 x 67
1688 x 57 x 67
1969 x 57 x 67
2249 x 57 x 67
2810 x 57 x 67
3371 x 57 x 67
4493 x 57 x 67



d +100 mm



582 x 76 x 67
863 x 76 x 67
1143 x 76 x 67
1424 x 76 x 67
1704 x 76 x 67
1985 x 76 x 67
2265 x 76 x 67
2826 x 76 x 67
3384 x 76 x 67
4509 x 76 x 67



d +100 mm

For other dimensions
or shapes Lipo60-S

186

Material
aluminium
plastic

Optical system
opal diffuser
microprismatic optical system

Halla Smart
control via Bluetooth
sensor

Electrical connection

ON/OFF
DALI
DALI DT8 (TunableWhite)
emergency 1h
emergency 3h





www.halla.eu/lipo80

Single luminaires

Lipo80

One of the features you will appreciate on Lipo80 luminaires is the L-Click system, which facilitates the installation as the module clicks easily into the aluminium profile without the need for tools. This solution also prevents the direct contact with the LED technology, which makes its service life significantly longer. Lipo80 with the efficacy of up to 125lm/W comes in recessed, surface and pendant versions. In addition to perfect performance, the luminaire also offers a great price. It can be used in commercial, social and public spaces.

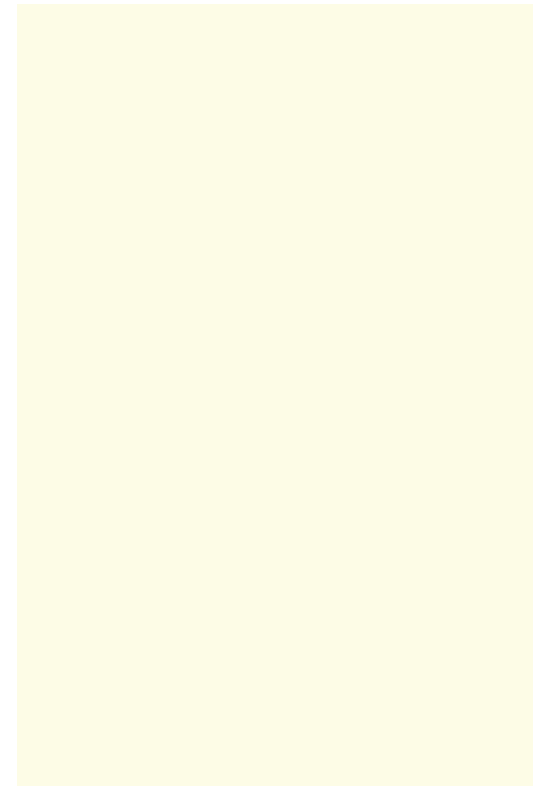

Installation



Light distribution



Colour



Dimensions

(l × w × h mm)



- 566 × 80 × 93
- 847 × 80 × 93
- 1127 × 80 × 93
- 1408 × 80 × 93
- 1688 × 80 × 93
- 1969 × 80 × 93
- 2249 × 80 × 93
- 2810 × 80 × 93
- 3371 × 80 × 93
- 4493 × 80 × 93



d +100 mm



- 582 × 98 × 84
- 863 × 98 × 84
- 1143 × 98 × 84
- 1424 × 98 × 84
- 1704 × 98 × 84
- 1985 × 98 × 84
- 2265 × 98 × 84
- 2826 × 98 × 84
- 3387 × 98 × 84
- 4509 × 98 × 84



d +100 mm

For other dimensions
or shapes Lipo80-S



Material
aluminium
plastic

Optical system
microprism with low UGR
matte aluminum parabolic louver
opal diffuser

Halla Smart
control via Bluetooth
sensor

Electrical connection

- ON/OFF
- DALI
- DALI DT8 (TunableWhite)
- emergency 1h
- emergency 3h



www.halla.eu/ilbi

Single luminaires

Ilbi

When Matúš Opálka locked himself in his studio for a month, we were wondering what he would come up with. In the end, he came up with a luminaire that looks both light and luxurious. The indirect distribution of light on two sides with reflection from the wall creates a pleasant soft light with adjustable intensity. The aluminium profile has been fitted with powerful LED boards. The luminaire comes in wall, surface and pendant versions. You can use Ilbi if you are looking for lighting for meeting rooms, all types of corridors, conference halls and social spaces.

Design: Matúš Opálka



Installation



Light distribution



Colour



Dimensions (l × w × h mm)t

896 × 37 × 106

1176 × 37 × 106

1456 × 37 × 106

1736 × 37 × 106

2016 × 37 × 106

2296 × 37 × 106

Material
aluminium

Optical system
opal diffusor

Electrical connection
ON/OFF
DALI

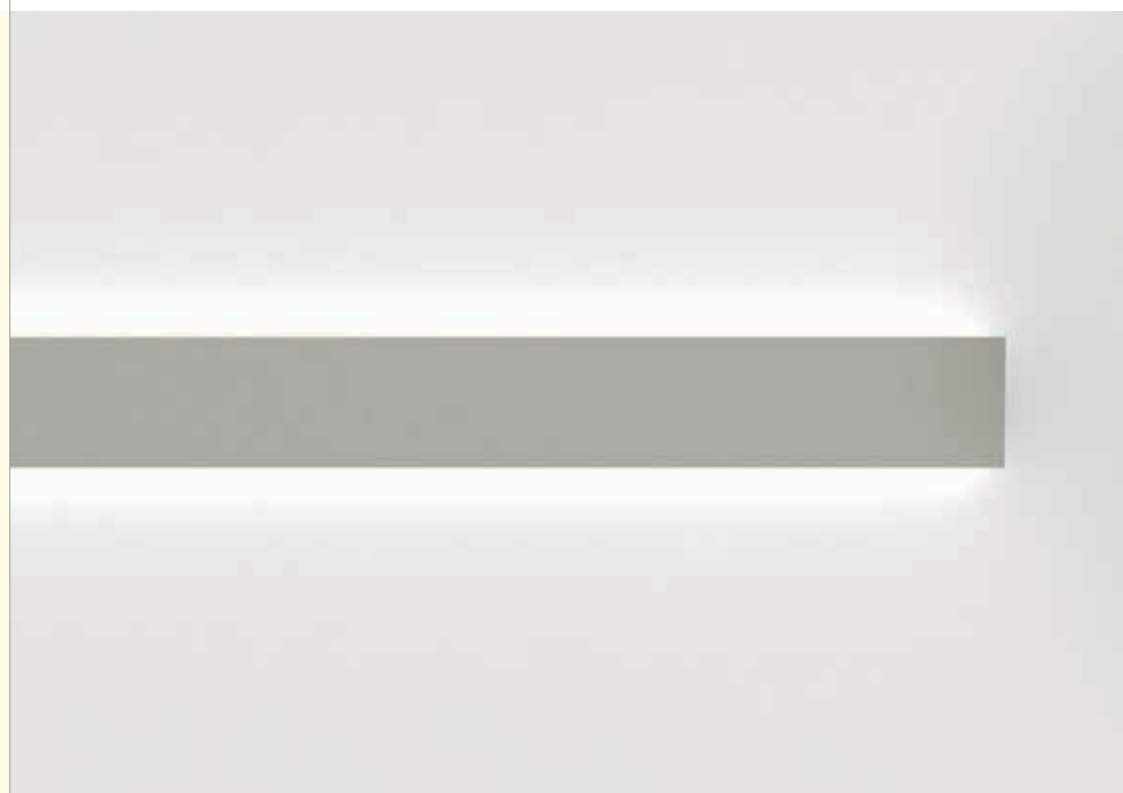



www.halla.eu/rundo

Single luminaires

Rundo

Circular luminaires with an aluminium profile come in two heights, 62 mm and 87 mm. Rundo luminaires feature an excellent efficacy of up to 145 lm/W, which can give the space lightness and appeal. The luminaires are pendant or flush-mounted, with direct or direct-indirect distribution of light creating an interesting light halo. A circular luminaire with a PMMA opal diffuser or microprismatic optical system is suitable for both commercial spaces and households. A playful and interesting effect can be created by combining different diameters. Rundo luminaires with a diameter of up to 1150 mm can be equipped with a motion sensor, daylight sensor or Bluetooth technology, which allows easy control of the luminaire from your smart device.



Installation



Light distribution



Colour



Dimensions

(ø × h mm)

400 × 62

500 × 62

600 × 62

850 × 62

1150 × 87

Material
aluminium

Optical system

Indirect component – opal diffuser
microprismatic optical system
opal diffuser

Halla Smart

control via Bluetooth
sensor

Electrical connection

ON/OFF

DALI

DALI DT8 (TunableWhite)

emergency 1h

emergency 3h



www.halla.eu/huge

Single luminaires

Huge

Circular luminaires with an aluminium profile with a height of 87 mm and an excellent luminous efficacy of up to 145 lm/W. A Huge family not only by its name, but also in terms of its functions and dimensions with a diameter of up to 1150 mm. These surface or pendant luminaires can be used as basic lighting features in commercial and residential spaces. Thanks to sophisticated technology, the luminaires do not cause glare and the lighting can be adapted to smaller or large commercial spaces. You can choose between a version with an opal diffuser made of PMMA or a microprismatic optical system.



Installation



Light distribution



Colour



Dimensions (\varnothing x h mm)

300 x 87
400 x 87
500 x 87
600 x 87
850 x 87
1150 x 87
1500 x 129

Material

aluminium

Optical system

opal diffuser
microprismatic optical system



Halla Smart

control via Bluetooth
sensor

Electrical connection

ON/OFF
DALI
DALI DT8 (TunableWhite)
emergency 1h
emergency 3h



www.halla.eu/puri

Single luminaires

Puri

We were thinking about how to achieve design purity, so we created a family of Puri recessed circular luminaires. Choose between the framed and frameless versions. You can mount it directly into the ceiling, without any cables or suspension fixtures. The framed version has a great advantage as it is very easy to disassemble. Using various diameters of the ceiling light, you can create combinations that will best suit the needs of your commercial spaces, offices, hotels or corridors. Puri blends in with the interior and can be easily combined with other families of circular luminaires.

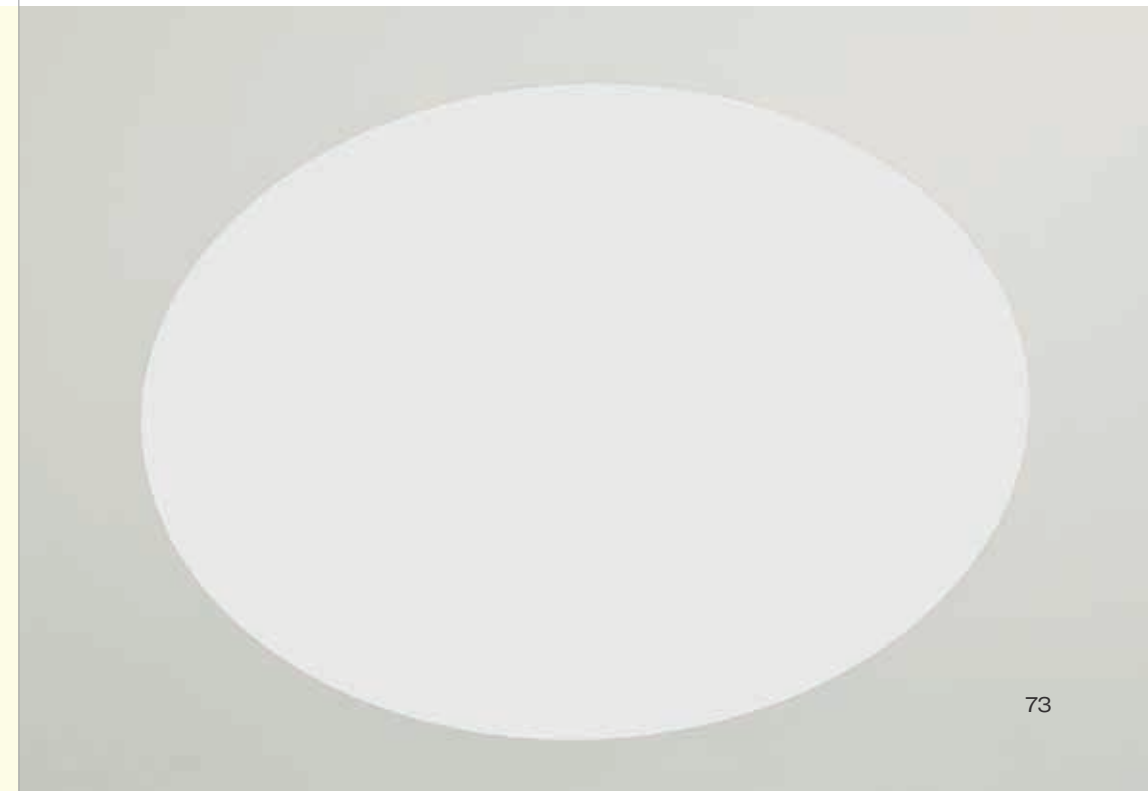

Installation



Light distribution



Colour



Dimensions

(\varnothing × h mm) □ ▤

420 × 90

520 × 90

620 × 90

870 × 90

1170 × 90

(\varnothing × h mm) □ ▤

435 × 125

633 × 125

924 × 125

1203 × 125

Material
aluminium

Optical system
opal diffusor
microprismatic optical system

Halla Smart
control via Bluetooth
sensor

Electrical connection
ON/OFF
DALI
DALI DT8 (TunableWhite)
emergency 1h
emergency 3h



www.halla.eu/rotao60

Single luminaires

Rotao60

The designer circular luminaire Rotao60 comes in a large number of diameters, thanks to which it fits well into various social and commercial spaces. You can also use it to decorate your living room or a meeting room. If you combine the luminaire with microprismatic optics, its efficacy can be surprising even in an office. Pendant versions of the Rotao60 luminaire with a diameter of up to 800 mm are suspended on suspension wires which converge into a single ceiling cup, while larger diameters are suspended on wires that run perpendicular to the ceiling.



Installation



Light distribution



Colour



Dimensions
(ø × h mm)

- 603 × 65
- 800 × 65
- 1140 × 65
- 1515 × 65
- 2050 × 65
- 2440 × 65
- 2980 × 65

Material
aluminium
plastic

Optical system

Indirect component – segments
with opal diffuser
microprismatic optical system
opal diffuser

Halla Smart

control via Bluetooth

Electrical connection

ON/OFF
DALI
DALI DT8 (TunableWhite)

Halla Acoustic

Ecophone
Natural moss





www.halla.eu/rotao100

Single luminaires

Rotao100

The Rotao100 designer luminaire pays tribute to geometric beauty. Its circular shape is sure to catch the eye of many admirers. The inner opening will also optically lighten up your commercial, office and home spaces. The luminaire has been fitted with a LED source with an efficacy of up to 150 lm/W, hidden behind the opal diffuser in the aluminium profile. Its surface has been treated with a baked-on powder coating available in three shades – unobtrusive white, elegant gray and timeless black, or you can pick a colour from the Halla RAL chart.



Installation



Light distribution



Colour



Dimensions
(ø × h mm)

- 600 × 87
- 850 × 87
- 1200 × 87
- 1500 × 87
- 2000 × 87
- 2500 × 87
- 3000 × 87

Material
aluminium

Optical system
Indirect component – segments
with opal diffuser
microprismatic optical system
opal diffuser

Halla Smart
control via Bluetooth

Electrical connection
ON/OFF
DALI
DALI DT8 (TunableWhite)

Halla Acoustic
Ecophone
Natural moss



www.halla.eu/indi

Single luminaires

Indi



The Indi luminaire, designed by Matúš Opálka, has won a number of awards, such as the Red Dot Award, the iF Design Award and the German Design Award. This circular luminaire direct-indirect distribution of light and dimensions from 1 to 4 meters can be used in meeting rooms, all types of corridors, conference halls and social spaces. The aluminium profile has been fitted with powerful LED boards. The indirect distribution of light on two sides creates a pleasant soft light with adjustable intensity.



Design: Matúš Opálka



Installation



Light distribution



Colour



Dimensions
(ø × h mm)

- 1000 × 106
- 1500 × 106
- 2010 × 106
- 2466 × 106
- 3012 × 106
- 3558 × 106
- 4000 × 106

Material
aluminium

Optical system
opal diffusor

Halla Smart
control via Bluetooth

Electrical connection
ON/OFF
DALI
DALI DT8 (TunableWhite)

Halla Acoustic
Ecophone
Natural moss



www.halla.eu/kvado

Single luminaires

Kvado

The Kvado family luminaires are made of a high-quality aluminium profile and are available in versions with both direct and direct-indirect distribution of light. Their simple shape and quality of workmanship make them suitable for any space. The luminaires can combine an opal diffuser or microprismatic optics. Thanks to all this, you can use them in administrative buildings, shopping centres, public spaces or residential buildings. Both pendant and surface versions are available in various colours according to our Halla RAL chart.



Installation



Light distribution



Colour



Dimensions

(l x w mm)

350 x 350

600 x 600

900 x 900

1200 x 350

1500 x 350

Material
aluminium

Optical system

Indirect component - opal diffuser
microprismatic optical system
opal diffuser

Halla Smart

control via Bluetooth
sensor

Electrical connection

ON/OFF

DALI

DALI DT8 (TunableWhite)

emergency 1h

emergency 3h



www.halla.eu/burbu

Single luminaires

Burbu

In the Burbu family, we have rounded off the corners of the squares and made rectangles into ovals. These luminaires with an ideal profile height create a positive and pleasant atmosphere in the space. The luminaires are made of a high-quality aluminium profile and are available in versions with both direct and direct-indirect distribution of light. Surface, wall or pendant luminaires of the Burbu family in various colours are ideal for hotel lobbies, entrance halls, offices, shops as well as households.



Installation



Light distribution



Colour



Dimensions (l x w mm)

350 x 350

600 x 600

1222 x 155

1522 x 155

Material
aluminium

Optical system

Indirect component – opal diffuser
microprismatic optical system
opal diffuser

Halla Smart

control via Bluetooth
sensor

Electrical connection

ON/OFF
DALI
DALI DT8 (TunableWhite)
emergency 1h
emergency 3h





www.halla.eu/fini

Single luminaires

Fini

A single luminaire, Fini, is an invisible luminaire that will enhance the atmosphere of any interior. The luminaires are adjustable which will help you achieve an ideal light effect without any shadows. You can line up a number of single luminaires that come in the lengths of 850 mm, 1130 mm, 1410 mm or 1690 mm. We offer three levels of luminous flux, a tuneable white version and an important IP40 protection. The height available for installing the luminaire should be at least 25 cm, which will help achieve an optimal light effect by adjusting the tilt of the luminaire.

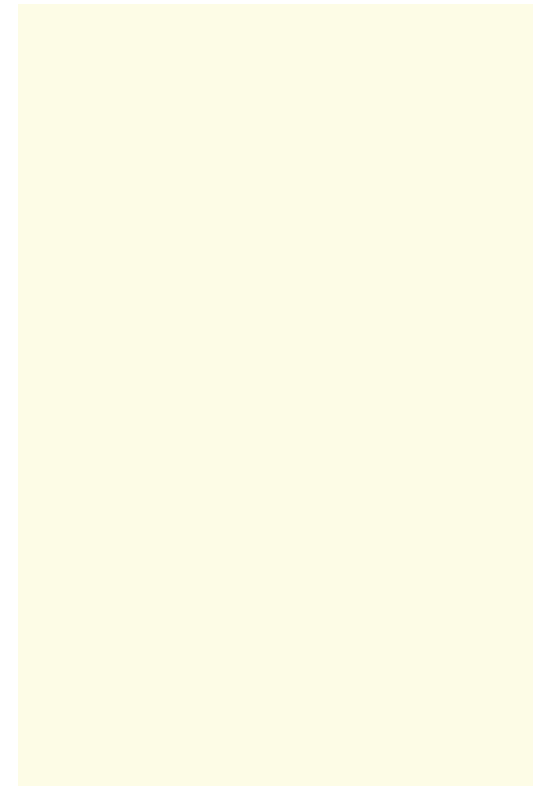

Installation



Light distribution



Colour



Dimensions
(l x w x h mm)

850 x 68 x 60

1130 x 68 x 60

1410 x 68 x 60

1690 x 68 x 60

Material
aluminium
plastic

Optical system
opal diffuser

Halla Smart
control via Bluetooth

Electrical connection
ON/OFF
DALI
DALI DT8 (TunableWhite)



www.halla.eu/stan

Single luminaires

Stan

The Stan luminaire with direct and direct-indirect distribution of light has been designed for comfortable and efficient work. It excels not only in its technical parameters, but also the narrow profile of the head itself, thanks to which the luminaire looks decent, professional and can easily blend in with the surroundings. The luminaire is fitted with an optical element consisting of a combination of optical lenses and a plastic parabolic louver, thanks to which the optical materials are not visible and therefore the luminaire does not dazzle. The louver comes in both the basic matt black and matt white colours. The luminaires of the Stan family are designed for both table mounting and free standing, so you can move them freely at any time, thus adapting the arrangement of the items in the room according to your needs.



Installation



Light distribution



Colour



Dimensions (l × w × h mm)



610 × 47 × 780
1185 × 47 × 1400



1185 × 47 × 1950



d +100 mm

Material
aluminium
plastic
steel

Optical system

Indirect component – opal diffusor
plastic louver with low UGR
microprismatic optical system

Halla Smart

control via Bluetooth
sensor

Electrical connection

ON/OFF
dimming button





www.halla.eu/sineli

Single luminaires

Sineli

Ordinary free standing luminaires have long been out of the game. We have designed and developed an ideal designer luminaire of the Sineli family, which will provide you with comfort at work and will improve your concentration. The Sineli luminaires are designed for both table mounting and free standing, so you can move them freely at any time, thus adapting the arrangement of the items in the room according to your needs. Sturdy construction and weight prevent accidental tipping over and ensure reliable stability. The shape of Sineli resembles a spaceship arriving from a distant galaxy, which can make your office, meeting room or private apartment look more impressive.



Installation



Light distribution



Colour



Dimensions

(l x w x h mm)



920 x 360 x 1950



920 x 360 x 1350

Material
aluminium
steel

Optical system
microprismatic optical system

Halla Smart
control via Bluetooth
sensor

Electrical connection
ON/OFF
dimming button



www.halla.eu/leira

Single luminaires

Leira

Leira smart luminaires will win you over not only with their simple design, but mainly with several ways to control the light intensity. The version with non-dimmable electronic ballast will fit perfectly into areas with permanent lighting, e.g. a lobby while luminaires with a dimmer switch will be appreciated, for example, at the reception. The model with a motion sensor will provide automatic dimming in a meeting room. And the office? The best option there is the version with an addressing unit that dims and lights up all the luminaires in the room on the basis of the detection of people and keeps the room perfectly lit for work. Leira luminaires have been designed as a minimalist element suitable for most interiors with the possibility of rearranging the space without unnecessary installations when you only need to move the luminaire.



Installation



Light distribution



Colour



Dimensions (l × w × h mm)



615 × 325 × 1305



615 × 325 × 1945

Material
aluminium
steel

Optical system
Indirect component – pure plastic housing
microprismatic optical system

Halla Smart
control via Bluetooth
sensor

Electrical connection
ON/OFF
dimming button





www.halla.eu/shift

Single luminaires

Shift

Designer Kryštof Nosál has created a luminaire with unrivalled variability. In addition, the Shift family of single luminaires allows for any method of installation. You can choose between a semi-recessed, surface and pendant version. The spot LED luminaire consists of 1, 2, 3 or 5 light sources, which can be moved along the axis of the luminaire body, tilted up to an angle of 45° and rotated up to 355°. The luminaire has 4 beam angles of 15°, 25°, 36°, 60°.



Design: Kryštof Nosál



Installation



Light distribution



Colour



Dimensions

reflector:
(\varnothing x h mm)

95 x 50

85 x 200

base:

(l x w x h mm)

420 x 85 x 92

720 x 85 x 92

1020 x 85 x 92

Material

aluminium

Optical system

reflector

transparent plexiglass

diffusor

Halla Smart

control via Bluetooth

Electrical connection

ON/OFF

DALI

Accessories

linear optics

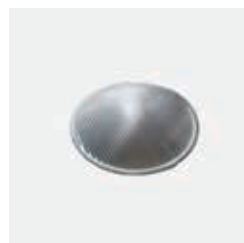

diffusion foil



replaceable reflector



electric unit

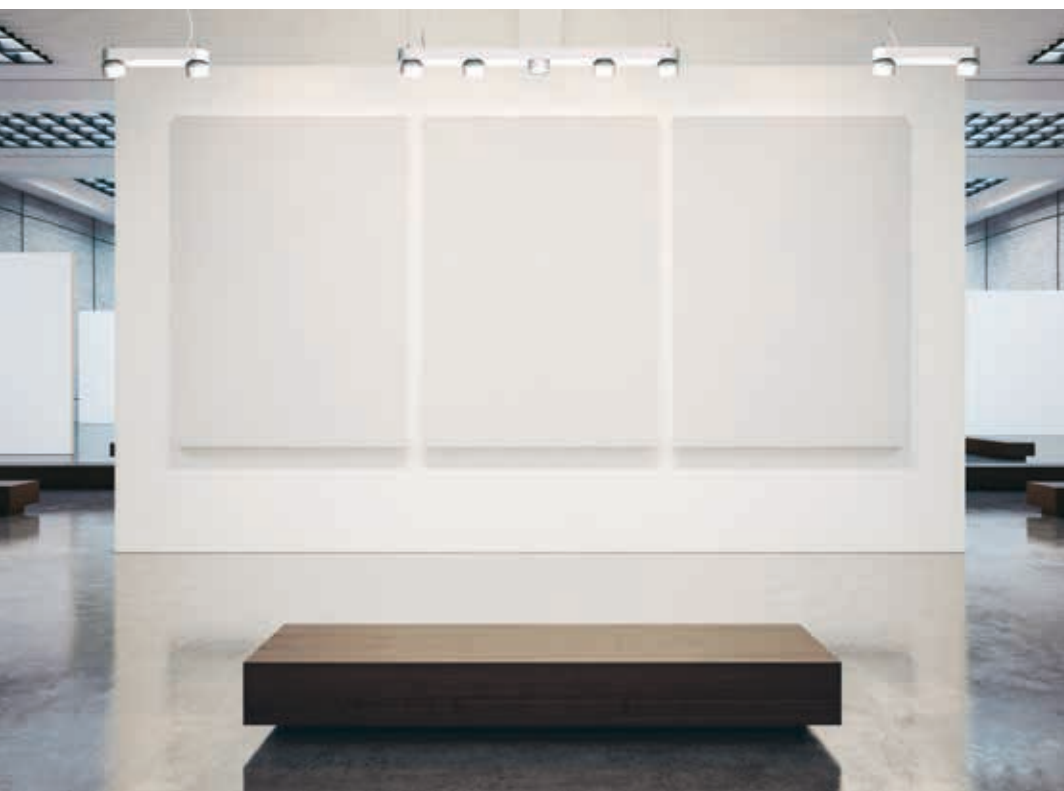

www.halla.eu/drob

Single luminaires

Drob

A dimmable, tilting track luminaire, whose shape is slightly reminiscent of headlights used on vintage cars. It features high-brightness LEDs with colour rendering of $Ra > 80$ or $Ra > 90$, transparent plexiglass or satin diffuser. The luminaires use adapters for the Global Track three-circuit tracks. Thanks to their minimalist design, they have lower luminous fluxes and are therefore more suitable for smaller shops with lower ceilings, such as drugstores or pharmacies. However, they can also be used in bars or less formal lobbies.



Installation



Light distribution



Colour



Dimensions ($\varnothing \times h$ mm)

85 x 60

Material aluminium

Optical system

reflector
transparent plexiglass
satin diffuser

Halla Smart control via Bluetooth

Electrical connection

ON/OFF
DALI



www.halla.eu/vali55-t

Single luminaires

Vali55-T

If you are looking for a really decent-looking cylindrical track luminaire of small dimensions with a high-quality aluminium construction and good light parameters, there is not much to think about – Vali55-T will be just for you. You will use it mainly to illuminate smaller sales areas such as showcases or a specific product. Vali55-T can also illuminate art objects and in some cases they can also be used in households. The luminaires have been fitted with adapters for the 3-phase Global Track from Nordic Aluminium.





Accessories

diffusion foil



replaceable reflector



Installation



Light distribution



Colour



Dimensions
(ø × h mm)

55 × 160

Material
aluminium
plastic

Optical system
reflector
diffusor

Halla Smart
control via Bluetooth

Electrical connection
ON/OFF
DALI





www.halla.eu/vali55

Single luminaires

Vali55

Its dimensions make the Vali55 luminaire the smallest cylindrical luminaire in our product range. The luminaires feature 4 types of reflectors with various angles of luminosity, thanks to which it also provides a large variability of light outputs. Vali55 has a very subtle minimalist shape, so it fits into a lot of interiors, where it always looks discreet and unobtrusive. The Luminaire comes in a surface, pendant or semi-recessed version, which greatly increases their versatility of use. All of this makes them suitable for commercial premises, bars or hotels or even residential buildings.





Installation



Light distribution



Colour



Dimensions
(ø x h mm)

55 x 160

Material
aluminium
plastic

Optical system
diffusor
reflector

Electrical connection

ON/OFF
DALI

Accessories

reflector



diffusion foil



www.halla.eu/vali80-t

Single luminaires
Vali80-T

We have managed to minimize the dimensions of the Vali80-T luminaires while maintaining very good lighting parameters. We also managed to reduce the casing of the luminaire to 75% of the surface. The luminaires offer a direct type of light distribution, four different beam angles of 21°, 28°, 40°, 63° and replaceable reflectors as optional accessories. The luminaires will be used predominantly to illuminate commercial spaces, galleries or showrooms. The luminaires have been fitted with adapters for the 3-phase Global Track from Nordic Aluminium. Vali80-T uses light sources with a colour rendering index of Ra90, which helps to show the true colours of the illuminated objects.



Installation



Light distribution



Colour



Dimensions
(ø x h mm)

80 x 160

Material

aluminium
plastic

Optical system

snoot
reflector
honeycomb
diffuser

Halla Smart

control via Bluetooth

Electrical connection

ON/OFF
DALI



Accessories

snoot



reflector



honeycomb

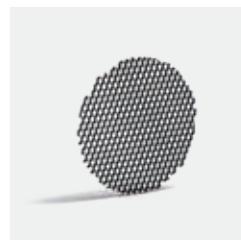

diffusion foil



www.halla.eu/vali80

Single luminaires
Vali80

When we combine design with functionality, we get luminaires from the Vali80 family. These cylindrical luminaires come in pendant, surface and semi-recessed versions. You can use them to illuminate your household, business and social spaces or, for example, bars. You can choose from three basic colours – white, black and silver or pick a colour from the Halla RAL chart.

special sources

Installation



Light distribution



Colour



Dimensions
(ø × h mm)



80 × 160



80 × 180

Material
aluminium
plastic

Optical system

snoot
reflector
honeycomb
diffusor

Electrical connection

ON/OFF
DALI

Accessories

snoot



reflector



honeycomb

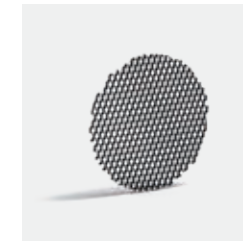

diffusion foil





www.halla.eu/sant-t



LIGHTING
DESIGN
AWARDS 2015



reddot design award
winner 2015



German
Design Award
2015

Single luminaires

Sant-T

The Dutch designer Rob van Beek has made this linear luminaire with opal diffuser look world-class. These luminaires, featuring direct-indirect distribution of light in a ratio of 90:10, are equipped with adapters for the Global Track three-circuit tracks and can also be used with tracks from the AAG Stuchi Company. They are fitted with balancing weights so that they do not bend the three-circuit track when tilted. They can be used mainly as additional lighting for commercial spaces, where they are used primarily to illuminate the space between shelves.

Design: Rob van Beek

Installation



Light distribution



Colour



Dimensions
(l x w x h mm)

1130 x 66 x 92

1410 x 66 x 92

Material

aluminium

plastic

Optical system

opal diffuser

Halla Smart

control via Bluetooth

Electrical connection

ON/OFF

DALI

DALI DT8 (TunableWhite)

emergency 1h

emergency 3h





www.halla.eu/lipo45-t

Single luminaires

Lipo45-T

The Lipo45-T luminaires are based on the concept of Lipo45 luminaires. In this case, however, the luminaires are installed in three-circuit tracks. These track luminaires with a profile width of only 45 mm are suitable for supplementing accent lighting provided by other luminaires from our product range, for example Vali55-T. With its diffused light, Lipo45-T helps to balance the lighting in the room by illuminating the communication zones, especially in the sales areas. The luminaires feature a support adapter in which the luminaire can be rotated along the Z axis thus modifying the arrangement of the system and also partially direct the light in a given space.





www.halla.eu/lipo60-t

Single luminaires

Lipo60-T

The Lipo60-T luminaires are based on the concept of Lipo60 luminaires. In this case, however, the luminaires are installed in three-circuit tracks. These luminaires are suitable for supplementing accent lighting provided by other luminaires from our product range, for example Vali80-T. With its diffused light, Lipo60-T helps to balance the lighting in the room by illuminating the communication zones, especially in the sales areas. The luminaires feature a support adapter in which the luminaire can be rotated along the Z axis thus modifying the arrangement of the system and also partially direct the light in a given space.

Installation



Light distribution



Colour



Dimensions (ø × h mm)

1127 × 47 × 59
1408 × 47 × 59

Material

aluminium
plastic

Optical system

plastic louver with low UGR
microprismatic optical system
opal diffusor

Halla Smart

control via Bluetooth

Electrical connection

ON/OFF
DALI
DALI DT8 (TunableWhite)





www.halla.eu/ture

Single luminaires

Ture

It is a circular recessed luminaire of the downlight type with an excellent UGR index < 19 up to 3000 lm, which means that the luminaire does not dazzle. The luminaire is suitable for offices, meeting rooms and, thanks to special sources, also for showrooms. RealWhite highlights the white, StrongColour highlights the selected colour, and RealColour emphasizes the colour of the object. With Tunable White you can set the colour temperature according to the time of day. With the help of these sources, the illuminated objects will look even more attractive. The IP54 class means high level of protection against the penetration of water and foreign matter. Thus, you can use this luminaire even in a demanding environment, such as a wellness centre. Its efficacy is up to 118 lm/W. Ture is available in three versions – a small luminaire with a diameter of 145 mm, a medium luminaire with a diameter of 185 mm and the largest luminaire with a diameter of 226 mm.

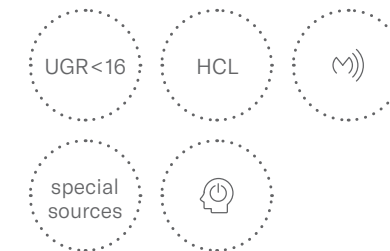

Installation



Light distribution



Colour



Dimensions
(l x w x h mm)

1127 x 57 x 67
1408 x 57 x 67

Material
aluminium
plastic

Optical system

opal diffusor
microprismatic optical system

Halla Smart

control via Bluetooth

Electrical connection

ON/OFF
DALI
DALI DT8 (TunableWhite)



Installation



Light distribution



Colour



Dimensions
(ø x h mm)

145 x 80

185 x 100

226 x 110

Material

aluminium

Optical system

opal diffuser

Halla Smart

control via Bluetooth

Electrical connection

ON/OFF

DALI

DALI DT8 (TunableWhite)

emergency 1h

emergency 3h

Accessories

electric unit



diffusion foil



www.halla.eu/ravo

Single luminaires

Ravo

This circular downlight luminaire has been designed for LED sources with an efficacy of up to 130 lm/W. Ravo luminaires have been made of polycarbonate plastic and a passive aluminium heat sink. The IP44 class provided by the versions with clear or structured plexiglass protects against the penetration of water and foreign matter. Ravo luminaire with a wider beam angle is a good solution for commercial and social spaces, car showrooms and communication zones. Its great advantage is the possibility to fit into a hole up to 230 mm in diameter with the help of additional accessories.

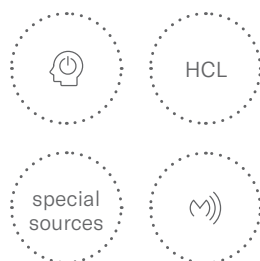

Installation



Light distribution



Colour



Dimensions (ø × h mm)



172 × 85
172 × 105



172 × 260

Material
aluminium
plastic

Optical system
pure housing
opal diffuser

Halla Smart
control via Bluetooth

Electrical connection
ON/OFF
DALI
DALI DT8 (TunableWhite)
emergency 1h
emergency 3h



Accessories

electric unit



circular trim





www.halla.eu/basi

Single luminaires

Basi

The Basi family of luminaires can be described simply – it has perfect light parameters and contains special sources. The high-brightness LEDs with colour rendering of Ra>80 or Ra>90 perfectly illuminates the desired object. That is what makes Basi especially suitable for shopping centres, cultural spaces or car showrooms. The RealColour technology with colour rendering of Ra>97 shows the colours of objects as naturally as daylight. StrongColour will highlight the desired colour and RealWhite will further improve the illumination of white objects. The luminaire is tilttable so if you need to illuminate moving objects, simply direct the luminous flux.

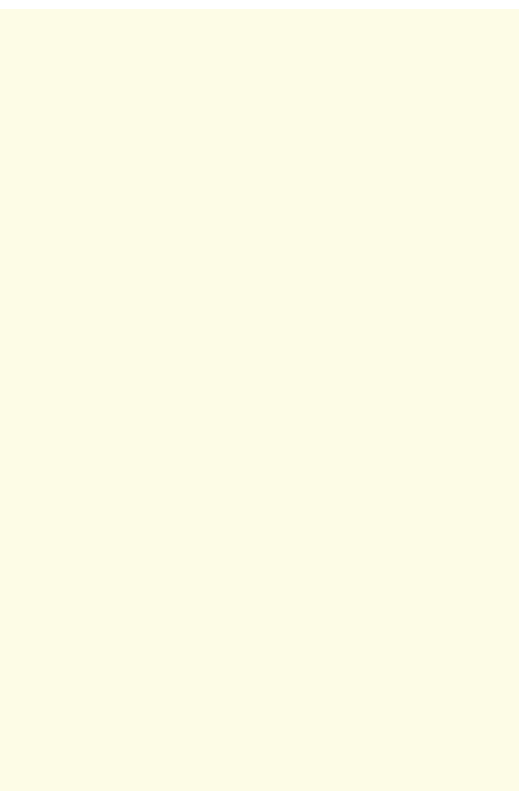



Installation



Light distribution



Colour

Dimensions
(ø x h mm)

162 x 95

162 x 115

Material
sheet metalOptical syste
reflectorHalla Smart
control via BluetoothElectrical connection
ON/OFF
DALI
DALI DT8 (TunableWhite)
emergency 1h
emergency 3h

Accessories

electric unit



www.halla.eu/gatu

Single luminaires

Gatu

If we combine a simple design with advanced functionality, we get the luminaires of Gatu family. The recessed luminaire with an adjustable reflector can be aimed at the required object. In addition to high-brightness LEDs with colour rendering of $Ra > 80$ or $Ra > 90$, the luminaire also contains a wide range of light sources. The RealWhite technology highlights the white, StrongColour highlights the selected colour, and RealColour with an extremely high colour rendering of $Ra > 97$ emphasizes the object's own colour. The illuminated object thus looks even more appealing, which makes Gatu luminaires suitable for commercial and cultural spaces, car showrooms and shop windows.

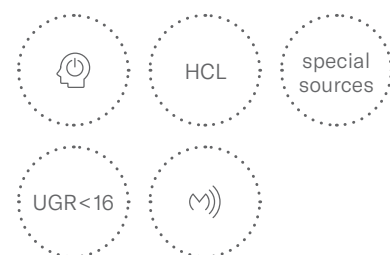

Installation



Light distribution



Colour



Dimensions
(l × w × h mm)

185 × 185 × 100

185 × 185 × 120

350 × 185 × 100

350 × 185 × 120

350 × 350 × 100

350 × 350 × 120

520 × 185 × 100

520 × 185 × 120

Material

sheet metal

Optical system

reflector

Halla Smart

control via Bluetooth

Electrical connection

ON/OFF

DALI

DALI DT8 (TunableWhite)

emergency 1h

emergency 3h



Accessories

electric unit





www.halla.eu/ilbi+

Single luminaires

Ilbi+

When you combine maximum usefulness with the minimalist design by Matúš Opálka, you get luminaires from the Ilbi+ family. We have, moreover, added a dual function. In addition to indirectly illuminating the room, it charges electronic devices via an integrated USB port and serves as a suspension system for inserting hooks, handles or shelves. The luminaire can be used to hang your clothes, place books, hang kitchen utensils or other daily necessities. The Ilbi+ luminaire is thus suitable for hotels, households, meeting rooms and, thanks to the IP44 version, also for wellness centres, bathrooms and pool locker rooms.

Design: Matúš Opálka





Installation



Light distribution



Colour



Dimensions
(l x w x h mm)

616 x 37 x 106

896 x 37 x 106

1176 x 37 x 106

Material
aluminium

Optical system
opal diffuser

Electrical connection
ON/OFF
DALI

Accessories

hook



wall fastening



shelf



Lighting systems

www.halla.eu/flumo60-s

Lighting system

Flumo60-S

Based on the great success of Flumo100-S, we decided to create its little brother called Flumo60-S with a narrower profile of 60 mm for a more decent look. It is a linear aluminium profile that winds along the ceiling in a perfect curve and navigates you through the space. The Flumo60-S luminaires are available in both pendant and surface versions. Thanks to a wide range of radii and lengths, the luminaire can be used to create countless shapes of light objects. If we add the possibility of direct or direct-indirect distribution of light and two types of optical systems, we get a universal tool for illuminating social, public or commercial spaces.



Installation



Light distribution



Colour



Dimensions
(l × w × h mm)

Straight profile

580 × 60 × 65
860 × 60 × 65
1140 × 60 × 65
1420 × 60 × 65
1700 × 60 × 65
1980 × 60 × 65
2260 × 60 × 65

Segments

∅ 603; 45, 60, 90, 120, 135°
∅ 800; 45, 60, 90, 120, 135°
∅ 1140; 45, 60, 90, 120, 135°
∅ 1515; 45, 60, 90, 120, 135°
∅ 2050; 45, 60, 90, 120°
∅ 2440; 45, 60, 90°
∅ 2980; 45, 60°

(∅ × h mm)

603 × 65
800 × 65
1140 × 65
1515 × 65
2050 × 65
2440 × 65
2980 × 65



Material
aluminium
plastic

Optical system
Indirect component – segments
with opal diffusor
microprismatic optical system
opal diffusor

Halla Smart
control via Bluetooth

Electrical connection
ON/OFF
DALI
DALI DT8 (TunableWhite)
emergency 1h
emergency 3h



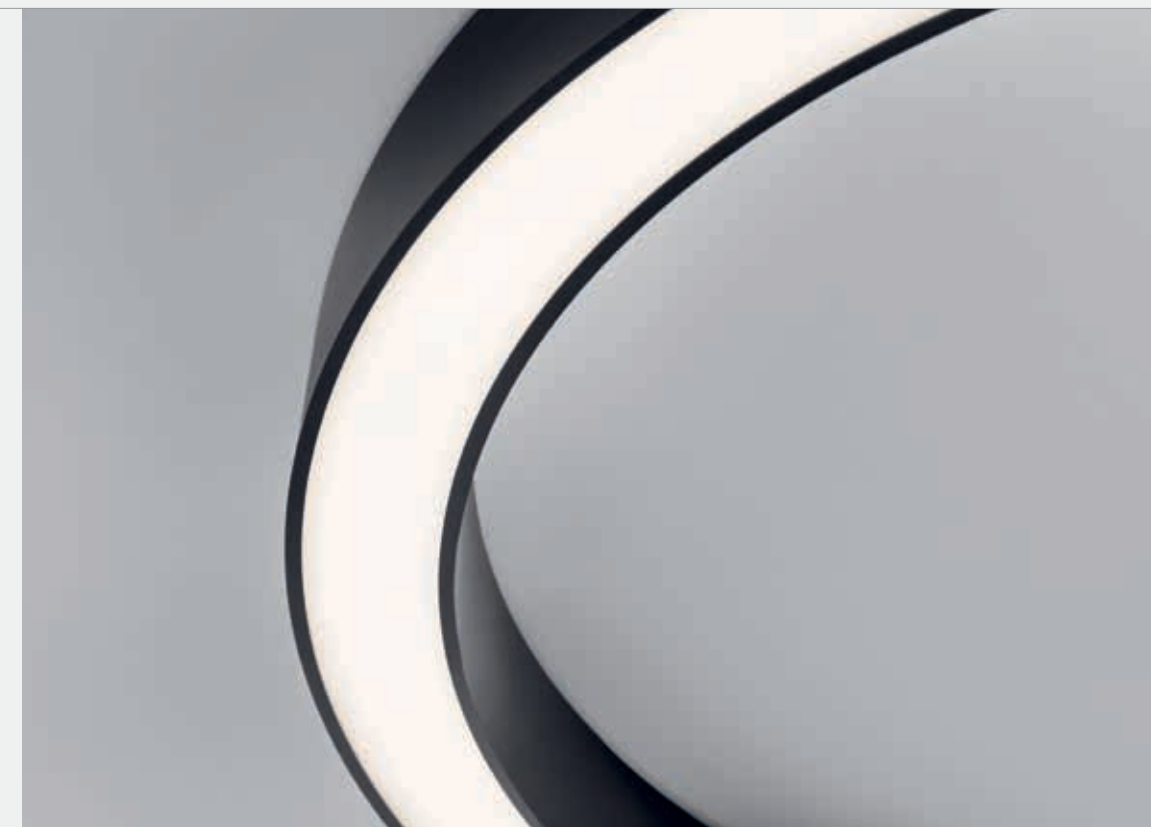
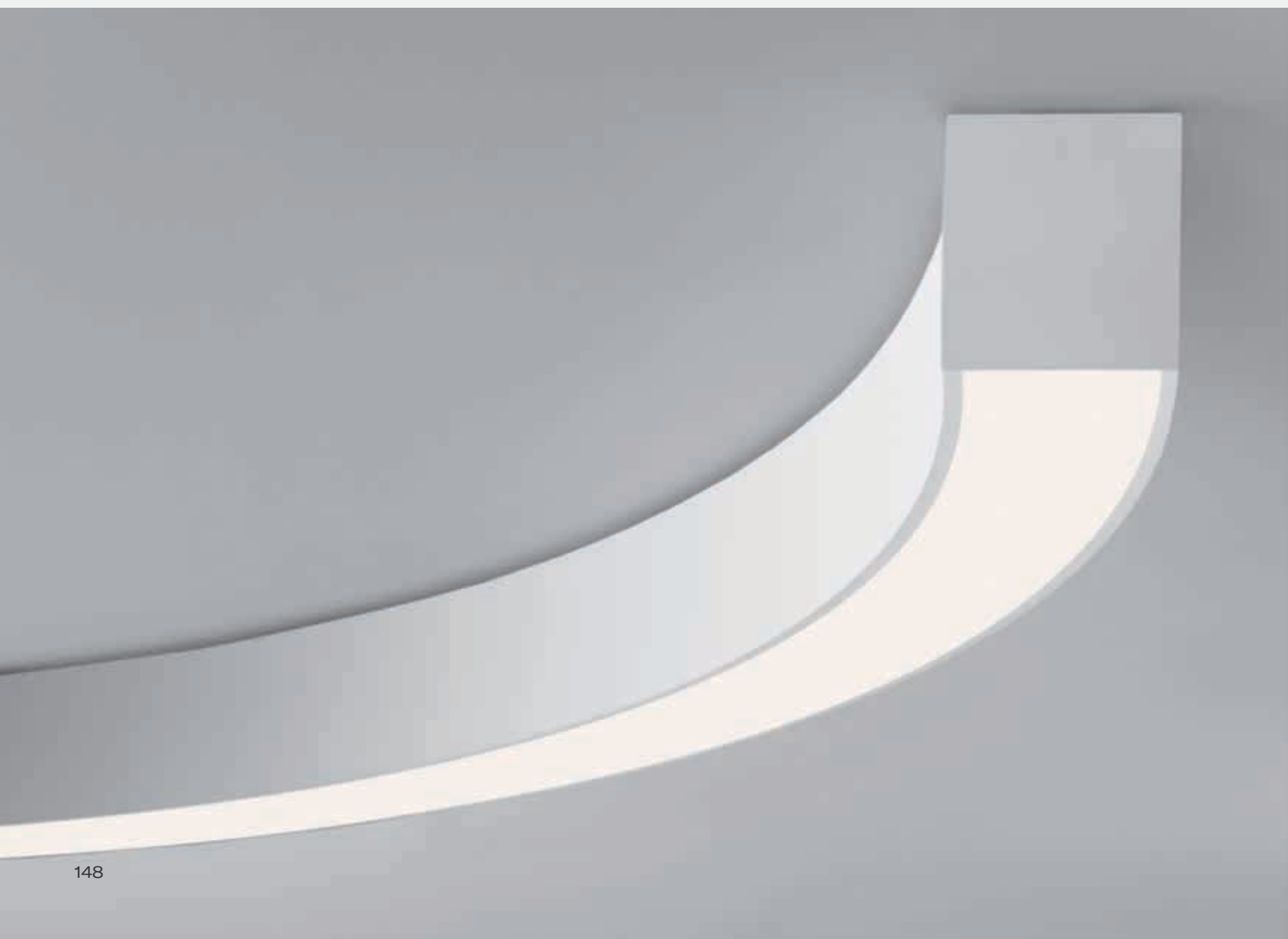

Accessories

coupler

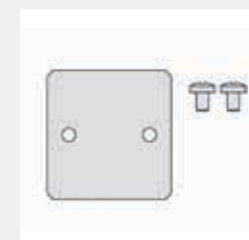

end cap



wire suspension



transparent cable

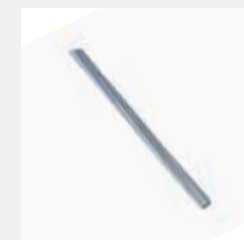

cup



Components

Straight profile



module C





www.halla.eu/flumo-s

Lighting system
Flumo100-S

Large spaces and long corridors – such places require something special: a linear aluminium profile that winds along the corridor in a perfect curve and navigates you through the space. The system luminaires of the Flumo100-S family will fully adapt to your possibilities and imagination. They can run straight or meander like the Colorado River. All the different lengths and angles mean that there are no limits. To assemble the Flumo-S lighting system you can choose between the pendant and surface versions. They are available with an opal diffuser or microprism in a wide range of colours according to the Halla RAL chart. The luminaires can be controlled via Bluetooth technology from your smart device.

UGR < 16 HCL



Installation



Light distribution



Colour



Dimensions

(l × w × h mm)

Straight profile

600 × 100 × 87

850 × 100 × 87

1200 × 100 × 87

1500 × 100 × 87

2000 × 100 × 87

2500 × 100 × 87

3000 × 100 × 87

Segments

∅ 850: 120 a 135°

∅ 1200, 1500 a 2000: 45, 90, 120 a 135°

∅ 2500 a 3000: 45, 60 a 90°

∅ 5400: 15 a 45°

(∅ × h mm)

850 × 87

1500 × 87

3000 × 87

5400 × 87

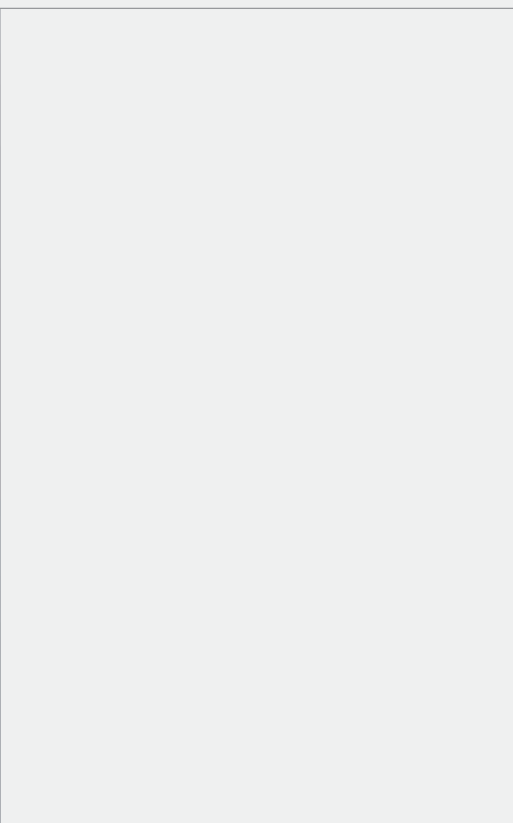

Material
aluminium
plastic

Optical system
Indirect component – segments
with opal diffusor
microprismatic optical system
opal diffusor

Halla Smart
control via Bluetooth

Electrical connection
ON/OFF
DALI
DALI DT8 (TunableWhite)
emergency 1h
emergency 3h



Accessories

wire suspension



end cap



transparent cable



cup



coupler

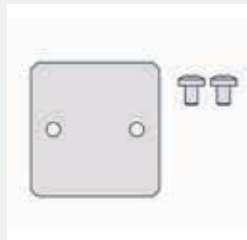

Components

Straight profile



module C



www.halla.eu/mila-s

Lighting system

Mila-S

One model, thousands of combinations. The Mila-S luminaire, designed by the world's leading designer Rob Van Beek, is innovative in every aspect. Thanks to a unique magnetic system, you can connect the luminaires to create spatial structures of various shapes without the need for tools. However, none of this would be possible without the latest LED technology, which is hidden inside the aluminium profiles in white, black or silver. In addition, the hidden light source does not create any undesirable shadows. Thanks to the possibility of dimming, the luminaire is suitable for showrooms, offices and various representative spaces. Even the name of this lighting system is perfectly thought through – Mila means “a thousand” in Italian.

Design: Rob van Beek



Installation



Light distribution



Colour



Dimensions

(l x w x h mm)

1040 x 445 x 70

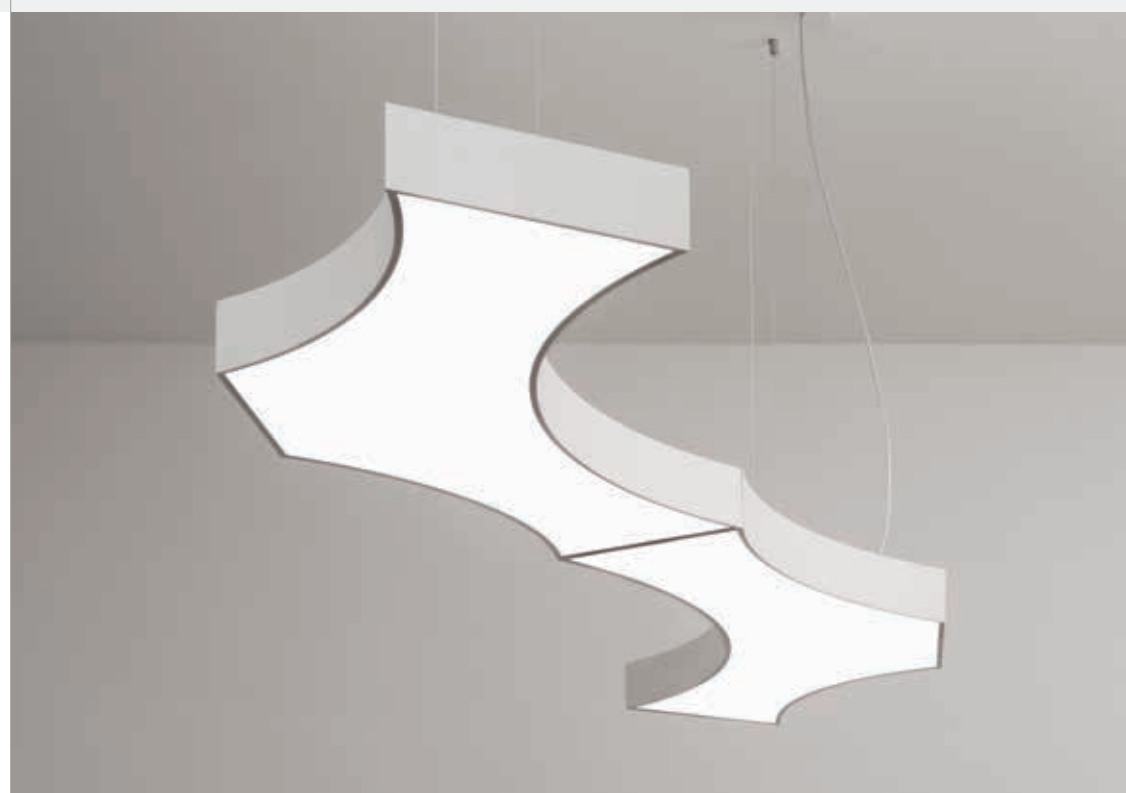

Material
aluminium

Optical system
Indirect component – opal diffuser
opal diffuser

Halla Smart
control via Bluetooth

Electrical connection
ON/OFF
DALI
DALI DT8 (TunableWhite)

Accessories

ceiling cup



wall fastening



wire suspension

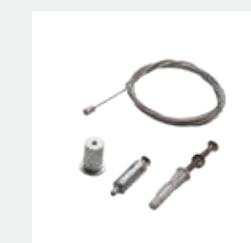

transparent cable



Components

basic module





www.halla.eu/unda-s

Lighting system

Unda-S

Rob van Beek came up with the Unda-S designer light while sitting on the shore and gazing at the sea. The three-dimensional LED lighting system was given the unique shape of a sea wave made of a bent aluminum sheet together with a diffuser, which allows excellent light transmission and scattering. You can use the luminaires individually, line them up together or connect six of them to make a circle. The creative concept of the Unda luminaire encourages design freedom. A series of three-dimensional circles, waves, and other shapes can be created using the bottom and top waves. The Unda luminaire will enliven your restaurant, bar, reception area, as well as an office, bank or a living room.

Design: Rob van Beek



Installation



Light distribution



Colour



Dimensions
(l x w x h mm)

1345 x 406 x 144

Material
aluminium

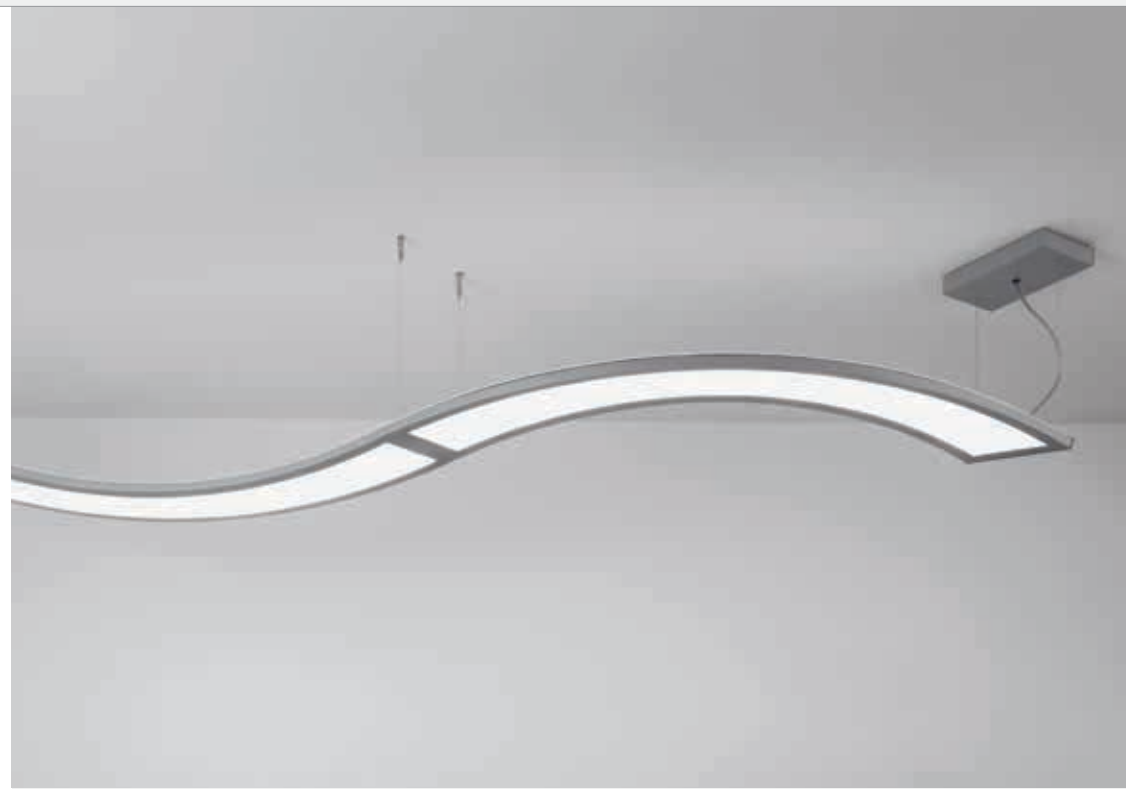

Optical system
Indirect component - opal diffuser
opal diffuser

Electrical connection
ON/OFF
DALI

Components

upper module



lower module



Accessories

end cap



ceiling cup



coupler

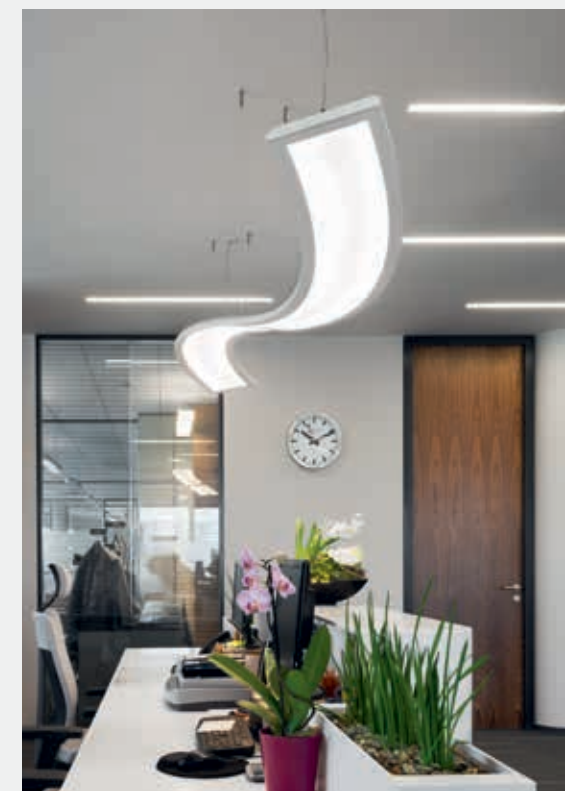
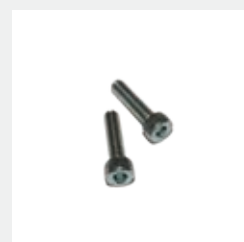

www.halla.eu/sant-s

Lighting system

Sant-S



The Dutch designer Rob van Beek gave this linear luminaire with an opal diffuser a world-class look. In the Czech Republic, Sant-S has specially been made for LED sources and Human Centric Lighting technology. This means that the light changes its intensity and colour temperature according to circadian rhythms. People thus feel natural in a closed space because the lighting simulates daylight. If you are looking for system linear luminaires for an office, school or a hospital, you have just found them. The attractive design of the luminaire has been complemented with high efficiency of as much as 150 lm/W and low power consumption due to dimmability. The direct-indirect light shines pleasantly, increases the brightness of the background and thus improves visual comfort.

Design: Rob van Beek

Installation



Light distribution



Colour



Dimensions (l x w x h mm)

562 x 66 x 92*

842 x 66 x 92*

1122 x 66 x 92*

1402 x 66 x 92*

1682 x 66 x 92*

1962 x 66 x 92*

2242 x 66 x 92*

Corner luminaire:

603 x 603 x 92*

* for these luminaires is possible extend their length about 70 mm, 140 mm, 210 mm

Material
aluminium
plastic

Optical system
opal diffuser

Halla Smart
control via Bluetooth

Electrical connection
ON/OFF
DALI
DALI DT8 (TunableWhite)
emergency 1h
emergency 3h



Accessories

ceiling cup



wall fastening



transparent cable



end cap



set for suspension into 3-phase track



wire suspension



coupler



Components

basic module



module L



www.halla.eu/zuli-s

Lighting system

Zuli-S

We realize that there is beauty in simplicity, so we have created our Zuli-S system luminaire. The Zuli-S luminaire is based on the timeless shape that everyone has known for many years. The luminaires come with a very efficient LED light source, thanks to which the luminaires have a very high economical and, last but not least, ecological value, as they require a relatively small amount of energy. Zuli-S luminaires can be fitted with a parabolic louver made of polished aluminium sheet or an opal diffuser.



Installation



Light distribution



Colour



Dimensions (l × w × h mm)

580 × 125 × 50*

855 × 125 × 50*

1135 × 125 × 50*

1415 × 125 × 50*

1695 × 125 × 50*

2255 × 125 × 50

* for these luminaires is possible extend their length about 70 mm, 140 mm, 210 mm



Material
aluminium
plastic

Optical system
Indirect component – opal diffusor
matte aluminium parabolic louver
microprismatic optical system
opal diffusor

Halla Smart
control via Bluetooth
sensor

Electrical connection
ON/OFF
DALI
DALI DT8 (TunableWhite)
emergency 1h
emergency 3h





Accessories

ceiling cup



coupler

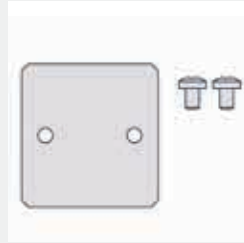

end cap



cable



wire suspension



www.halla.eu/lina45-s

Lighting system

Lina45-S

The Lina45-S system luminaires with direct-indirect distribution of light are made of aluminium profile and come in a pendant version. The lower part of the luminaire contains optical components and the upper part contains electrical components as well as the indirect part of the LED light sources. You can buy a version with an optical lens in combination with a plastic louvre, which makes the luminaires best suited for offices or spaces with a similarly high demand for an anti-glare solution. We also offer a version with an opal cover or microprismatic optics.



Installation



Light distribution



Colour



Dimensions
(l x w x h mm)

1122 x 47 x 59*

1403 x 47 x 59*

1683 x 47 x 59*

1964 x 47 x 59*

2244 x 47 x 59

Corner luminaire

596 x 596 x 59



d +100 mm

* for these luminaires is possible extend their length about 70 mm, 140 mm, 210 mm

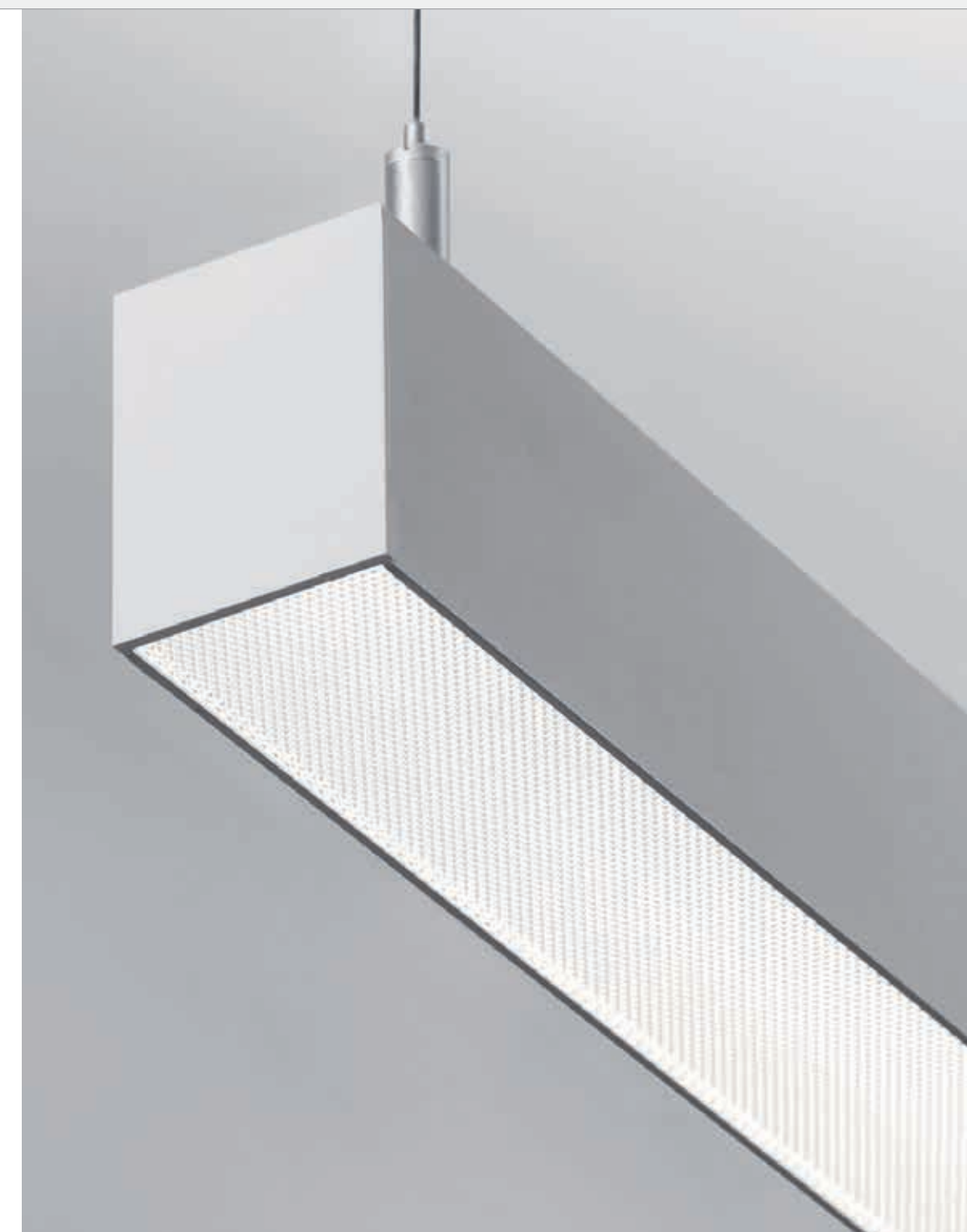

Material
aluminium
plastic

Optical system
Indirect component - opal diffusor
plastic louvre with low UGR
microprismatic optical system
opal diffusor

Halla Smart
control via Bluetooth
sensor

Electrical connection
ON/OFF
DALI
DALI DT8 (TunableWhite)
emergency 1h
emergency 3h

Accessories

cup



coupler

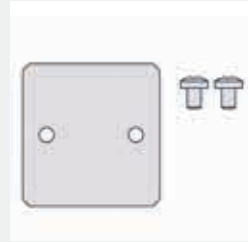

end cap



cable



set for suspension into 3-phase track



wire suspension



Components

basic module



module L





www.halla.eu/lina80-s

Lighting system
Lina80-S

The luminaires of Lina80-S family with direct-indirect distribution of light are available in both pendant and wall versions, including the illuminated corner segments. The system luminaires can be connected together to create various shapes or long lines, with overlapping joints that prevent any light from passing through, which makes them suitable for small offices as well as big halls. We offer versions with a louvre, an opal diffuser or a microprismatic optical system. An important parameter can be the efficacy of 115lm/W and the practical L-Click system.



Installation



Light distribution



Colour



Dimensions

(l × w × h mm)

561 × 80 × 93*

842 × 80 × 93*

1122 × 80 × 93*

1403 × 80 × 93*

1683 × 80 × 93*

1964 × 80 × 93*

2244 × 80 × 93



d +100 mm

Corner luminaire:

613 × 613 × 93

* for these luminaires is possible extend their length about 70 mm, 140 mm, 210 mm



Material
aluminium
plastic

Optical system
nepřímá složka – opálový difuzor
microprism with low UGR
opal diffuser
microprismatic optical system

Halla Smart
control via Bluetooth
sensor

Electrical connection
ON/OFF
DALI
DALI DT8 (TunableWhite)
emergency 1h
emergency 3h

Accessories

ceiling cup



wall fastening



coupler



end cap



transparent cable



wire suspension



set for suspension
into 3-phase track



coupler



Components

basic module



module L



module X



module T

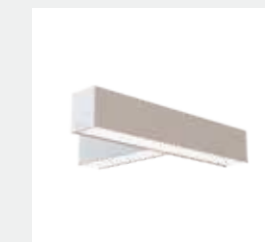

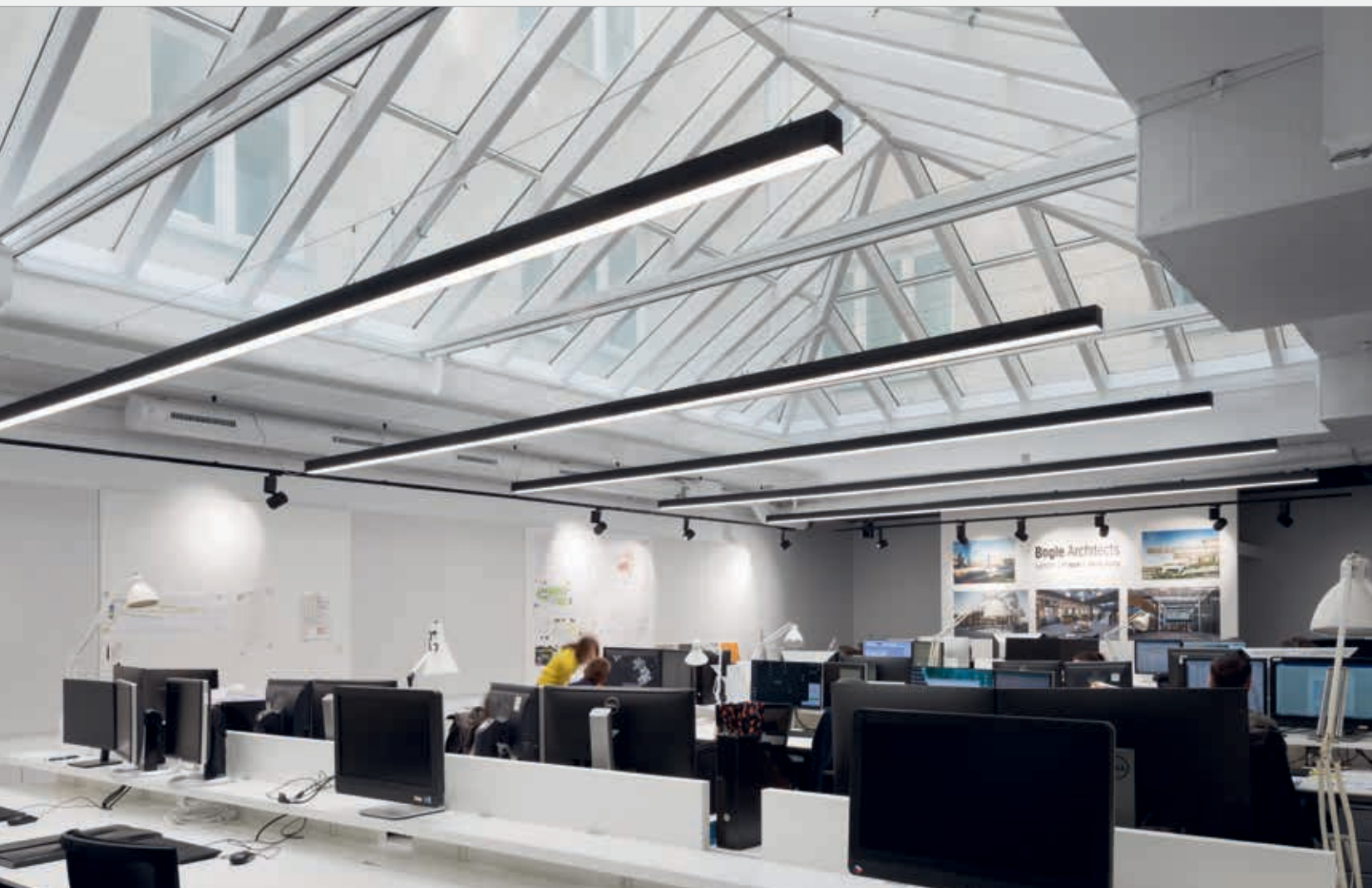

www.halla.eu/lipo35-s

Lighting system

Lipo35-S

The linear system luminaires of the Lipo35-S family provide one of the thinnest profiles in our product range. The luminaires with direct distribution of light are available in the pendant, surface, and recessed versions for ceiling installations and can also be mounted on the wall. In any case, you can line the luminaires up in a row thus creating the ideal length to meet your needs. Thanks to the option to extend and retract the opal diffuser, you can find the ideal combination of lights for a specific interior according to your needs. Thanks to this variability, Lipo35-S can be used in virtually any area, but especially in the social, public and commercial ones. Luminaires with an extended diffuser diffuse their light into a significantly larger area thus helping to soften the entire interior.



Installation



Light distribution



Colour



Dimensions
(l x w x h mm)



- 842 x 37 x 60 (75)
- 1122 x 37 x 60 (75)
- 1403 x 37 x 60 (75)
- 1683 x 37 x 60 (75)
- 1964 x 37 x 60 (75)
- 2244 x 37 x 60 (75)
- 2805 x 37 x 60 (75)
- 3366 x 37 x 60 (75)
- 4488 x 37 x 60 (75)

Corner luminaire

- 593 x 593 x 65
- 603 x 603 x 65



- 561 x 54 x 95
- 842 x 54 x 95
- 1122 x 54 x 95
- 1403 x 54 x 95
- 1683 x 54 x 95
- 1964 x 54 x 95
- 2244 x 54 x 95
- 2805 x 54 x 95
- 3366 x 54 x 95
- 4488 x 54 x 95

Corner luminaire

- 593 x 593 x 65
- 603 x 603 x 65

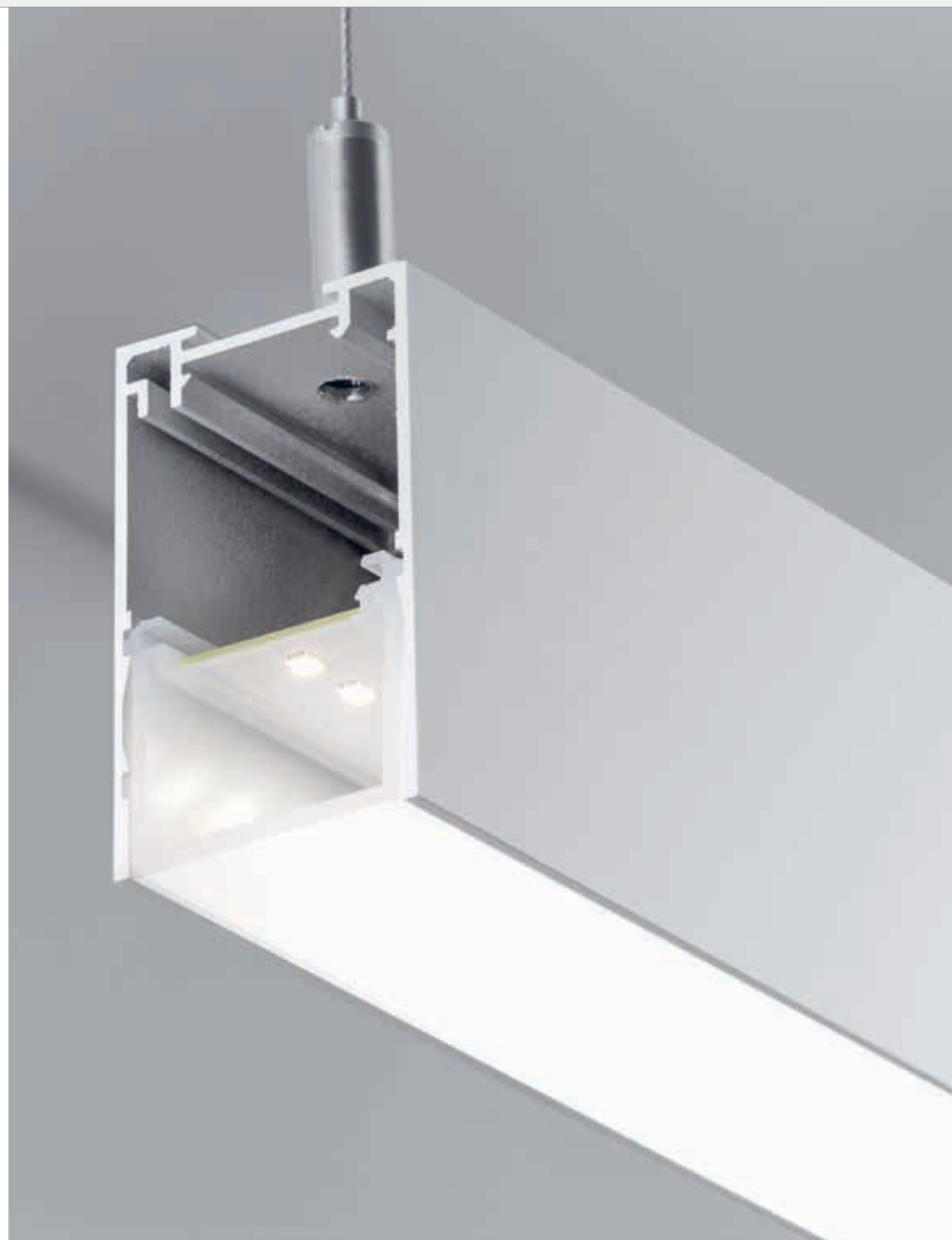

Material
aluminium
plastic

Optical system
opal diffusor

Halla Smart
control via Bluetooth

Electrical connection
ON/OFF
DALI
emergency 1h
emergency 3h

Accessories

cap



wall fastening



coupler

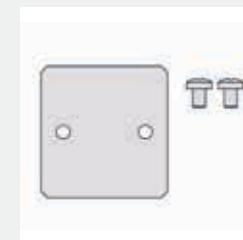

end cap



transparent cable



set for suspension into
3-phase track



wire suspension

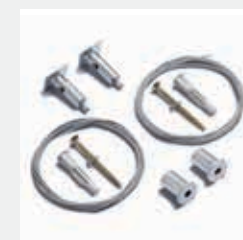

Components

basic module



module L

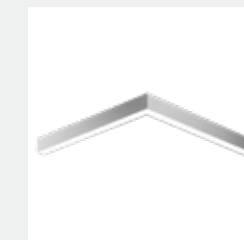



www.halla.eu/lipo45-s

Lighting system

Lipo45-S

Lipo45-S luminaires with direct distribution of light are made of an aluminium profile and are available in surface and pendant versions. You can buy a version with an optical lens in combination with a plastic louvre, which makes the luminaires best suited for offices or spaces with a similarly high demand for an anti-glare solution. We also offer a version with an opal cover or microprismatic optics. You can also choose whether you prefer metal end caps or plastic ones without visible screws.



Installation



Light distribution



Colour



Dimensions
(l x w x h mm)

1122 x 47 x 58 *

1403 x 47 x 58 *

1683 x 47 x 58 *

1964 x 47 x 58 *

2244 x 47 x 58

Corner luminaire

596 x 596 x 59



d +100 mm

* for these luminaires is possible extend their length about 70mm, 140mm, 210mm



Material
aluminium
plastic

Optical system
plastová mřížka s nízkým UGR
opal diffusor
microprismatic optical system

Halla Smart
control via Bluetooth
sensor

Electrical connection
ON/OFF
DALI
DALI DT8 (TunableWhite)
emergency 1h
emergency 3h

Accessories

cup



coupler

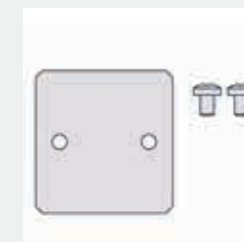

end cap



cable



set for suspension into
3-phase track



wire suspension



Components

basic module



module L

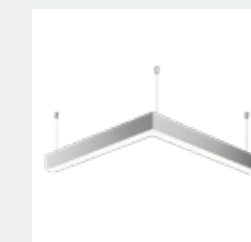

module with spots



www.halla.eu/lipo60-s

Lighting system
Lipo60-S

The Lipo60-S luminaires provide a combination of optical materials – an opal cover, microprisms and even directional spotlights, allowing a high versatility of use. The system luminaires can be lined up together into endless lines and various shapes. It can be used in commercial, social and public spaces. You will also appreciate the L-Click system, which will save you time and money. How? The module simply clicks into the profile, eliminating the hassle of assembly. By preventing direct contact with the LED technology, the service life of the luminaire is significantly extended.



Installation



Light distribution



Colour



Dimensions
(l x w x h mm)



- 561 x 57 x 67*
- 842 x 57 x 67*
- 1122 x 57 x 67*
- 1403 x 57 x 67*
- 1683 x 57 x 67*
- 1964 x 57 x 67*
- 2244 x 57 x 67*
- 2805 x 57 x 67*
- 3366 x 57 x 67*
- 4488 x 57 x 67

Corner luminaire

603 x 603 x 67



d +100 mm



- 561 x 76 x 67*
- 842 x 76 x 67*
- 1122 x 76 x 67*
- 1403 x 76 x 67*
- 1683 x 76 x 67*
- 1964 x 76 x 67*
- 2244 x 76 x 67*
- 2805 x 76 x 67*
- 3366 x 76 x 67*
- 4488 x 76 x 67

Corner luminaire

610 x 610 x 67



d +100 mm

* for these luminaires is possible extend their length about 70 mm, 140 mm, 210 mm



Material
aluminium
plastic

Optical system
opal diffusor
microprismatic optical system
reflector

Halla Smart
control via Bluetooth
sensor

Electrical connection
ON/OFF
DALI
DALI DT8 (TunableWhite)
emergency 1h
emergency 3h

Accessories

ceiling cup



wall fastening



coupler



end cap



transparent cable



wire suspension



set for suspension into 3-phase track



suspended/recessed profile



Components

basic module



module L



module T



module with spots



www.halla.eu/lipo80-s

Lighting system

Lipo80-S

The LED lighting system of the Lipo80-S family with efficacy of as much as 125 lm/W is available in a recessed, surface and pendant versions. Special technology prevents any light from passing through the joints of the system. In addition to great efficacy, the luminaire also features a great price. It can be used in commercial, social and public spaces. You will also appreciate the L-Click system, which will save you time and money. How? The module simply clicks into the profile, eliminating the hassle of assembly. By preventing direct contact with the LED technology, the service life of the luminaire is significantly extended.



Installation



Light distribution



Colour



Dimensions (l x w x h mm)



- 561 x 80 x 93*
- 842 x 80 x 93*
- 1122 x 80 x 93*
- 1403 x 80 x 93*
- 1683 x 80 x 93*
- 1964 x 80 x 93*
- 2244 x 80 x 93*
- 2805 x 80 x 93*
- 3366 x 80 x 93*
- 4488 x 80 x 93

Corner luminaire

613 x 613 x 93



d +100 mm



- 561 x 98 x 84*
- 842 x 98 x 84*
- 1122 x 98 x 84*
- 1403 x 98 x 84*
- 1683 x 98 x 84*
- 1964 x 98 x 84*
- 2244 x 98 x 84*
- 2805 x 98 x 84*
- 3366 x 98 x 84*
- 4488 x 98 x 84

Corner luminaire

622 x 622 x 84



d +100 mm

* for these luminaires is possible extend their length about 70 mm, 140 mm, 210 mm



Material
aluminium
plastic

Optical system
opal diffuser
microprismatic optical system
reflector

Halla Smart
control via Bluetooth
sensor

Electrical connection
ON/OFF
DALI
DALI DT8 (TunableWhite)
emergency 1h
emergency 3h

Accessories

ceiling cup



wall fastening



coupler



end cap



transparent cable



wire suspension



set for suspension into 3-phase track



suspended/recessed profile



Components

basic module



module L



module X



module T



Lighting system

Rofo-S

Integration that is the word which accurately characterizes the Rofo-S luminaires family. The luminaires are directly integrated to the ceiling system from the leading manufacturer Armstrong without a visible frame which means that they form an integral part of the ceiling. The Rofo-S luminaires do not require any other use and therefore it is very easy to use them. The advantage is not only a simple assembly but also a very elegant design of the entire lighting system. They can be used in offices, meeting rooms, auditoriums, or laboratories due to various optical material that can be used in the luminaries.

Installation

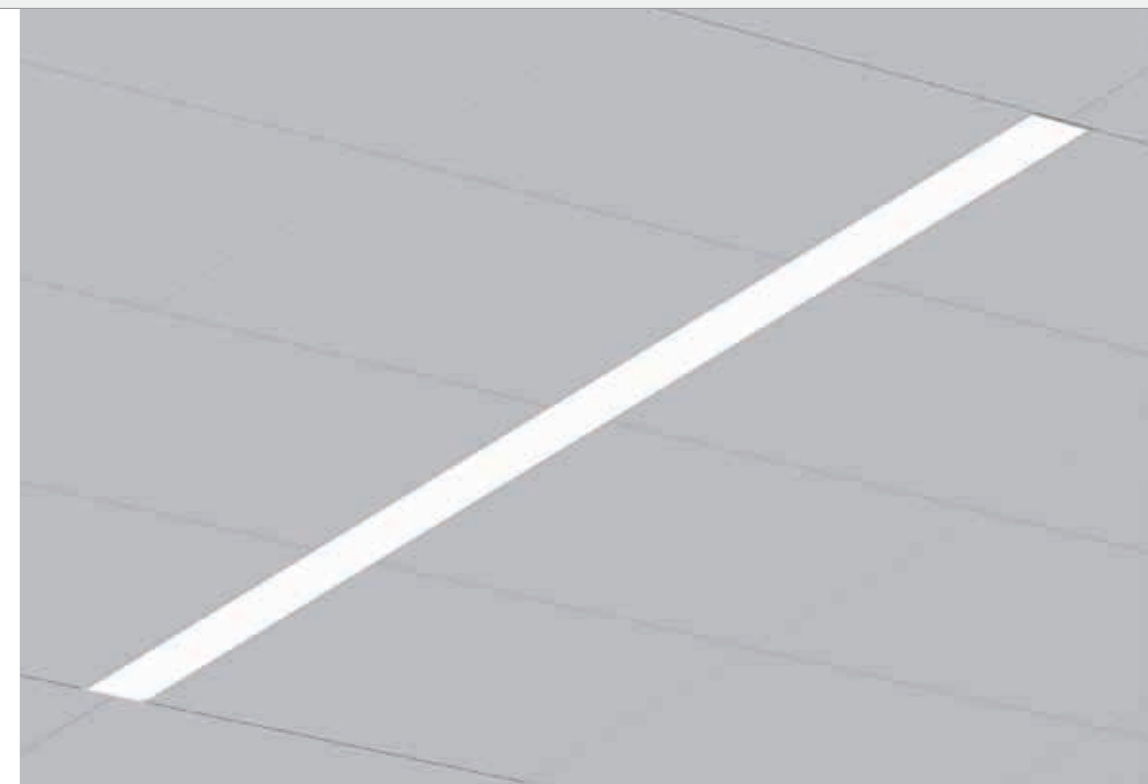

Light distribution

Colour
without colourMaterial
aluminiumOptical system
opal diffusor
microprismatic optical systemElectrical connection
ON/OFF
DALI
DALI DT8 (TunableWhite)
emergency 1h
emergency 3h

Legend

Type of installation

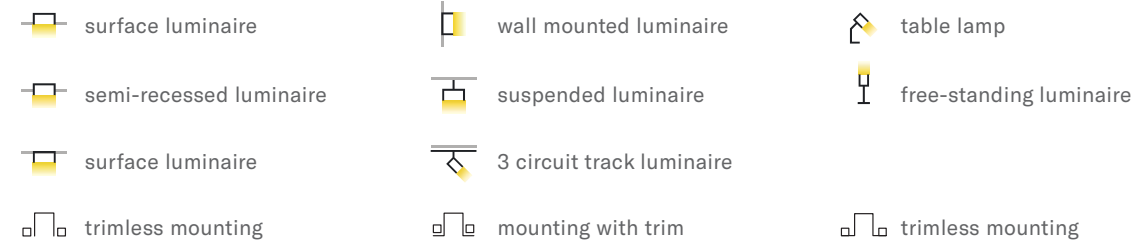

Light distribution



Colour

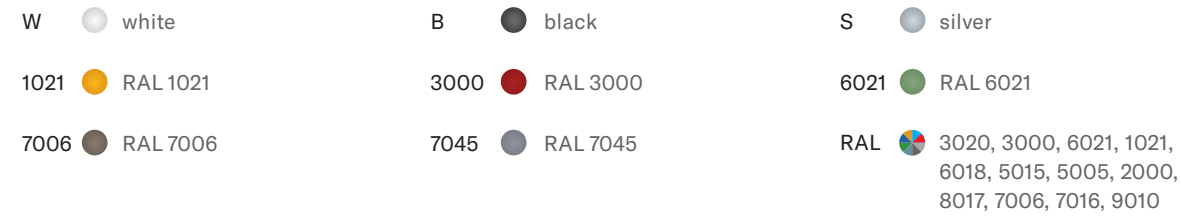

Icons

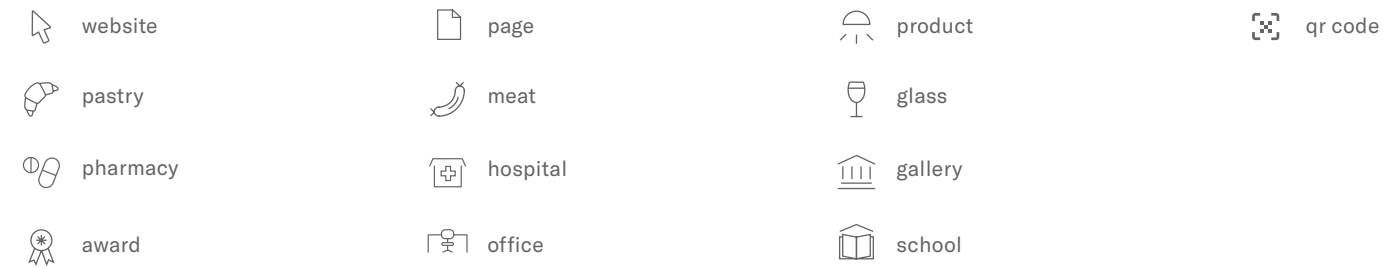

Technology

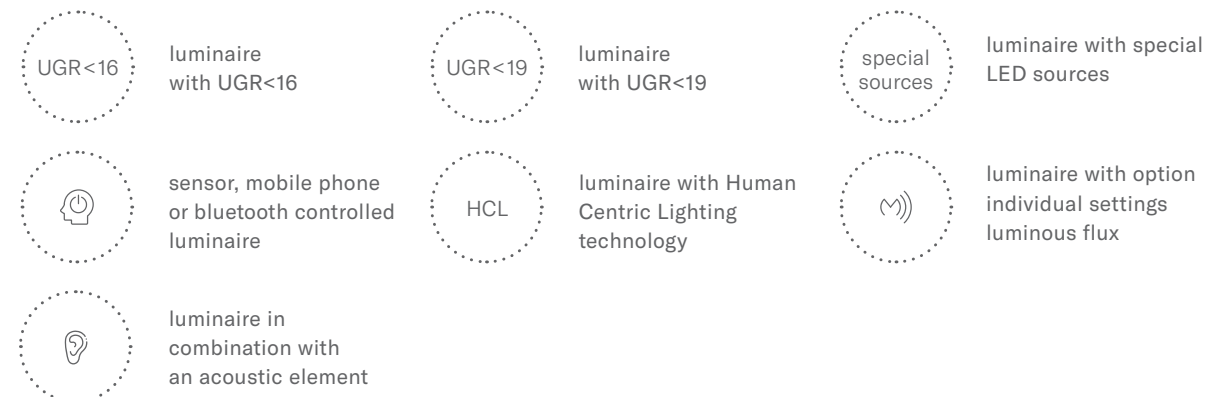

Contact

www.halla.eu
export@halla.cz
tech.support@halla.cz
tel. +420 286 880 161

Headquarters

Halla, a.s.
Litvínovská 288/11
190 00 Praha 9
Czech Republic

Factory

Halla, a.s.
Černčická 43
549 01 Nové Město nad Metují
Czech Republic

Graphic design

studio Creative Nights

Print

TISKÁRNA GRAFICO S.R.O.

© 2025 Halla

