

55-283\*-10G\*\*

LED

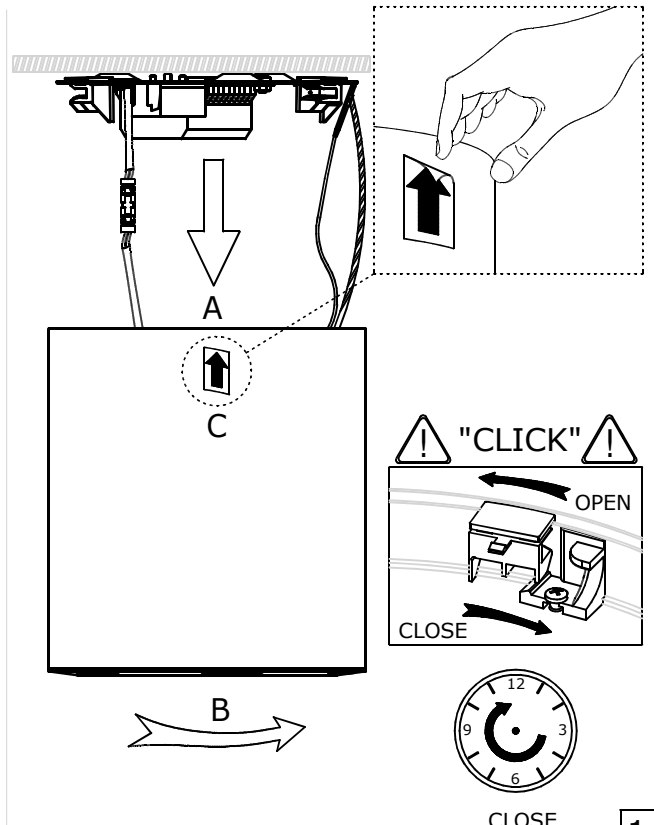

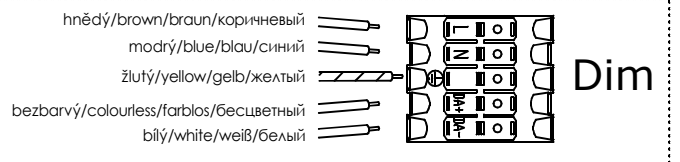
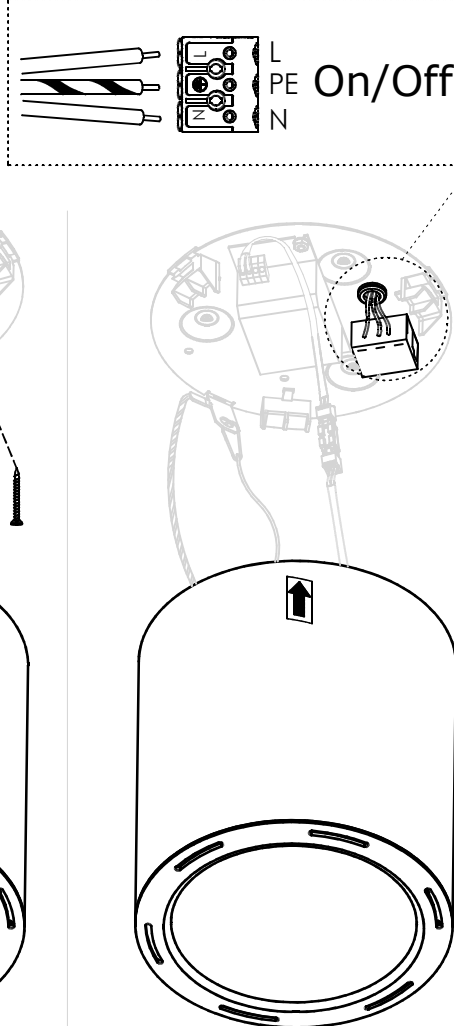
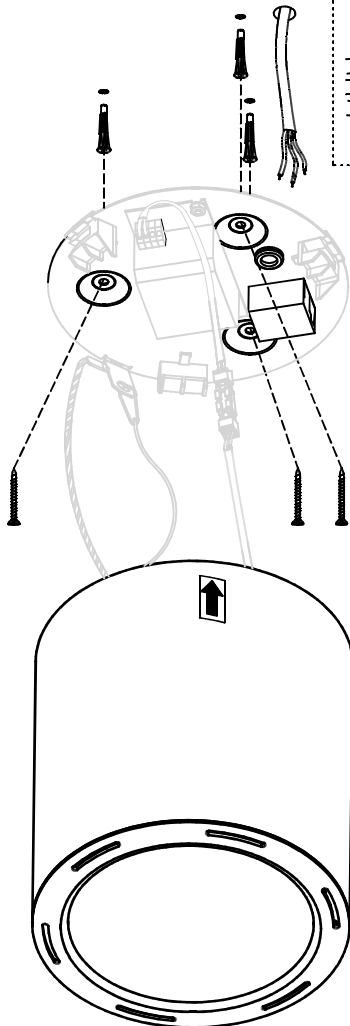
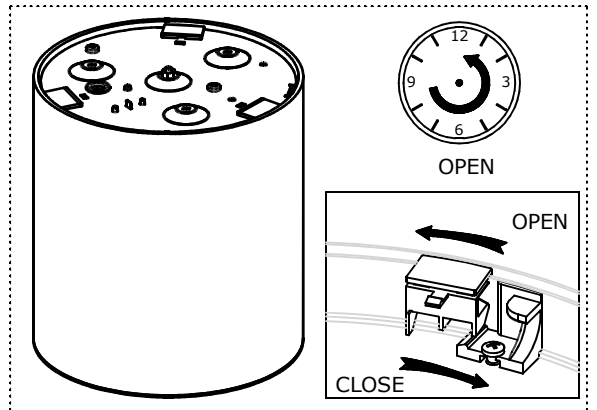
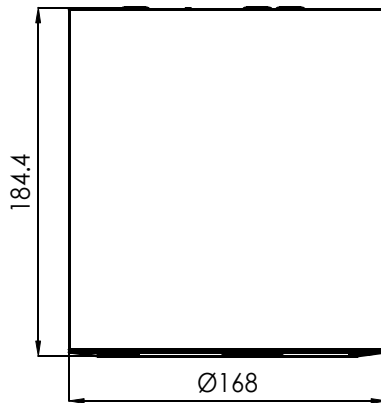
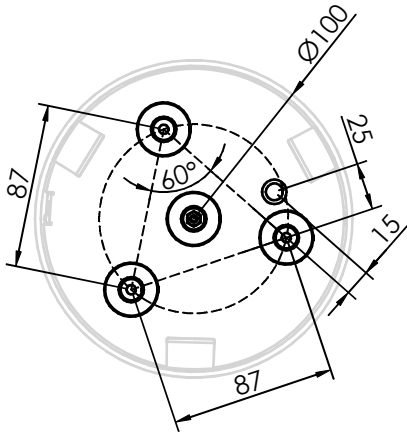
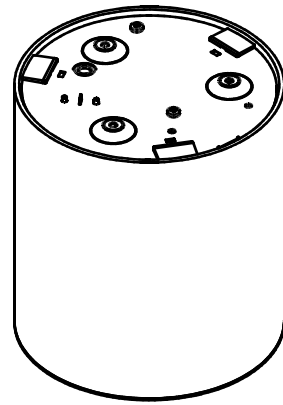
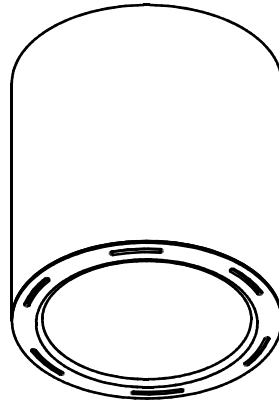
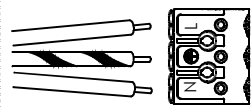

L PE N On/Off

hnědý/brown/braun/коричневый

modrý/blue/blau/синий

žlutý/yellow/gelb/желтый

bezbarvý/colourless/farblos/бесцветный

bílý/white/weiß/белый

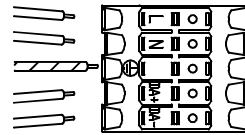

Dim

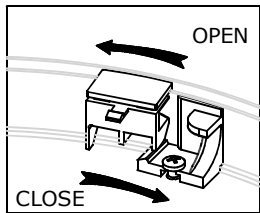
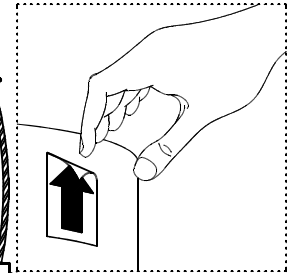
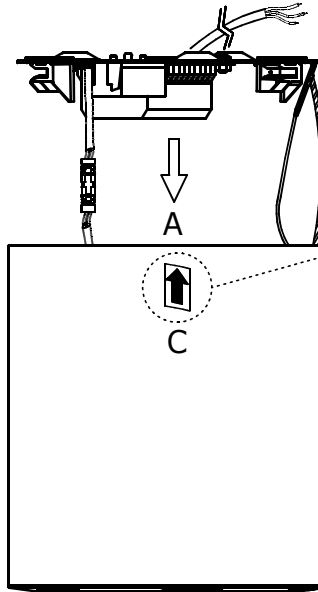
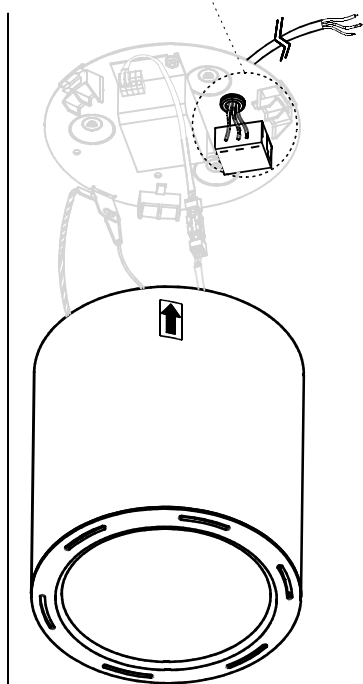
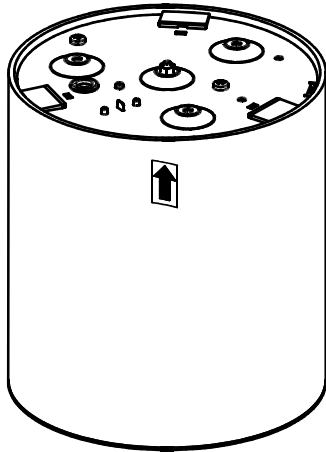

OPEN

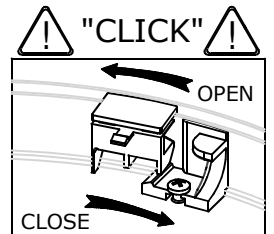

"CLICK"

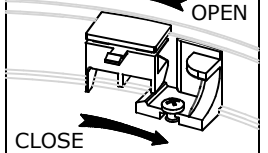

CLOSE

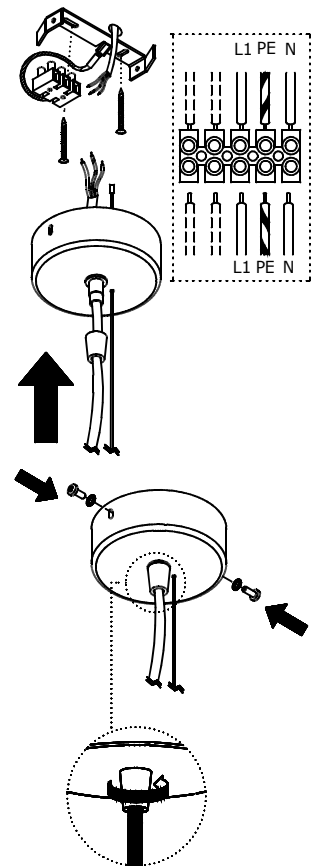
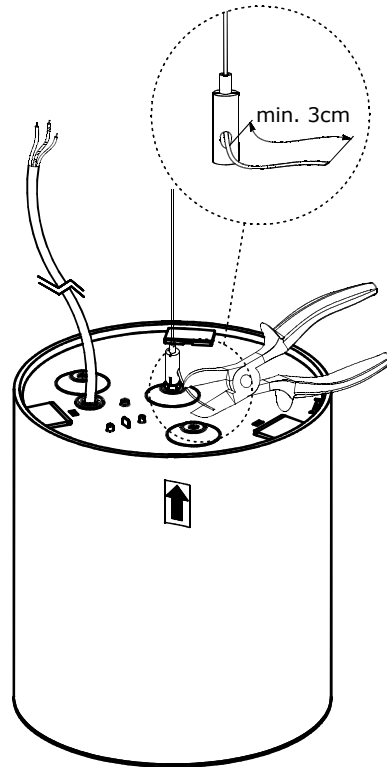
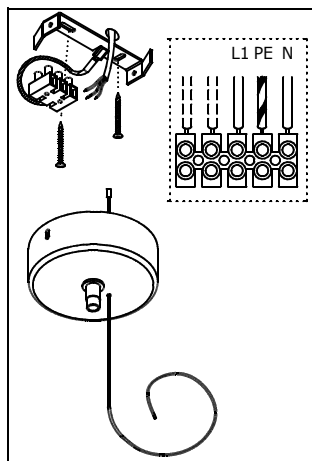
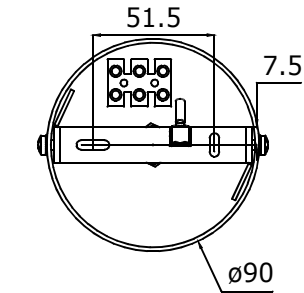
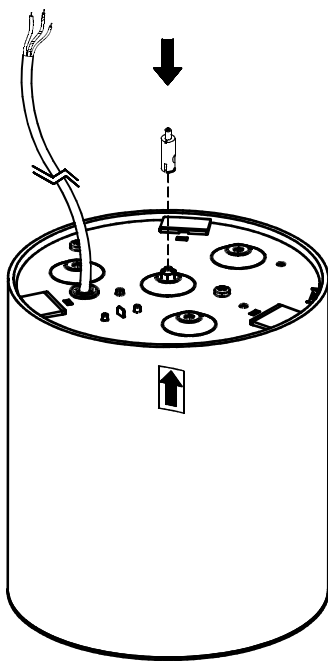

- Světelný zdroj v tomto svítidle smí vyměnit pouze výrobce nebo jeho smluvní servisní technik nebo podobně kvalifikovaná osoba!
- The light source in this luminaire may be replaced only by the manufacturer or its contractual service technician or a similarly qualified person!
- Die Lichtquelle dieser Leuchte darf nur vom Hersteller oder einem von ihm beauftragten Servicetechniker oder einer vergleichbar qualifizierten Person ersetzt werden.
- Источник света данного светильника может быть заменен только производителем, уполномоченным им сервисным техником или специалистом с соответствующей квалификацией

- Montáž smí provádět pouze pracovník s odbornou elektrotechnickou kvalifikací. Před prováděním jakékoliv údržby vypněte přívod el. proudu.
- The installation may only be carried by authorised specialist. Always switch-off the power supply before carrying out any maintenance.
- Die Leuchtenmontage kann nur von autorisiertem Fachpersonal durchgeführt werden. Vor der beliebigen Wartungsausführung die Einspeisung abschalten.
- Установка светильников разрешена только квалифицированным электромонтером. Перед любым ремонтом или уходом за светильником необходимо выключить питание.

- Výrobce nenesie zodpovednosť za nesprávne zachádzanie s produktom.
- The manufacturer is not responsible for the incorrect use and assembly of its products.
- Der Hersteller trägt keine Verantwortung für eine falsche Verwendung des Produktes.
- Производитель не несет ответственности за неправильное обращение с продуктом.

◦ Instructions for wiring  
◦ Elektrische Schaltung

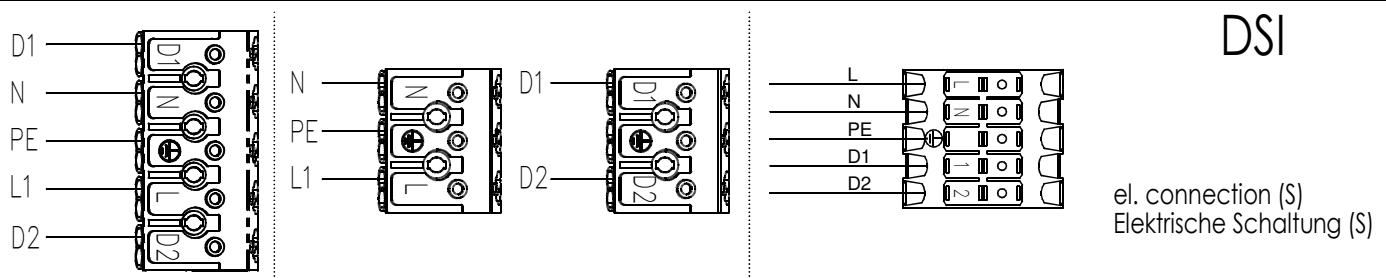
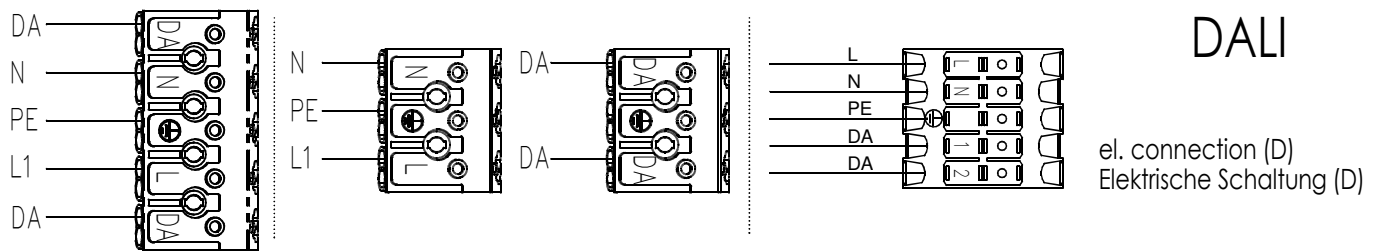
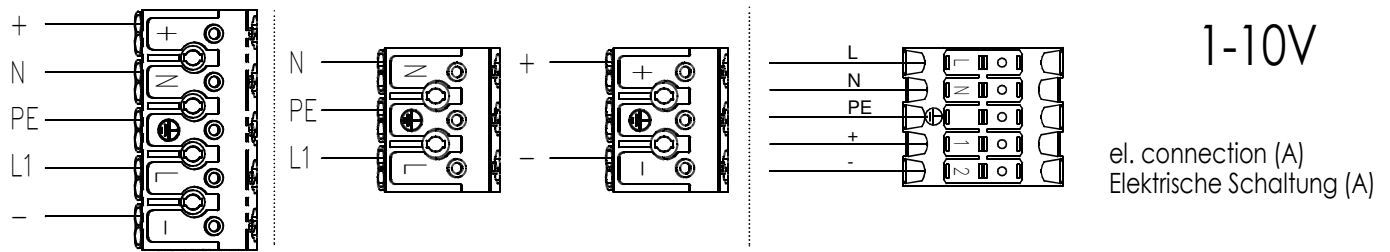
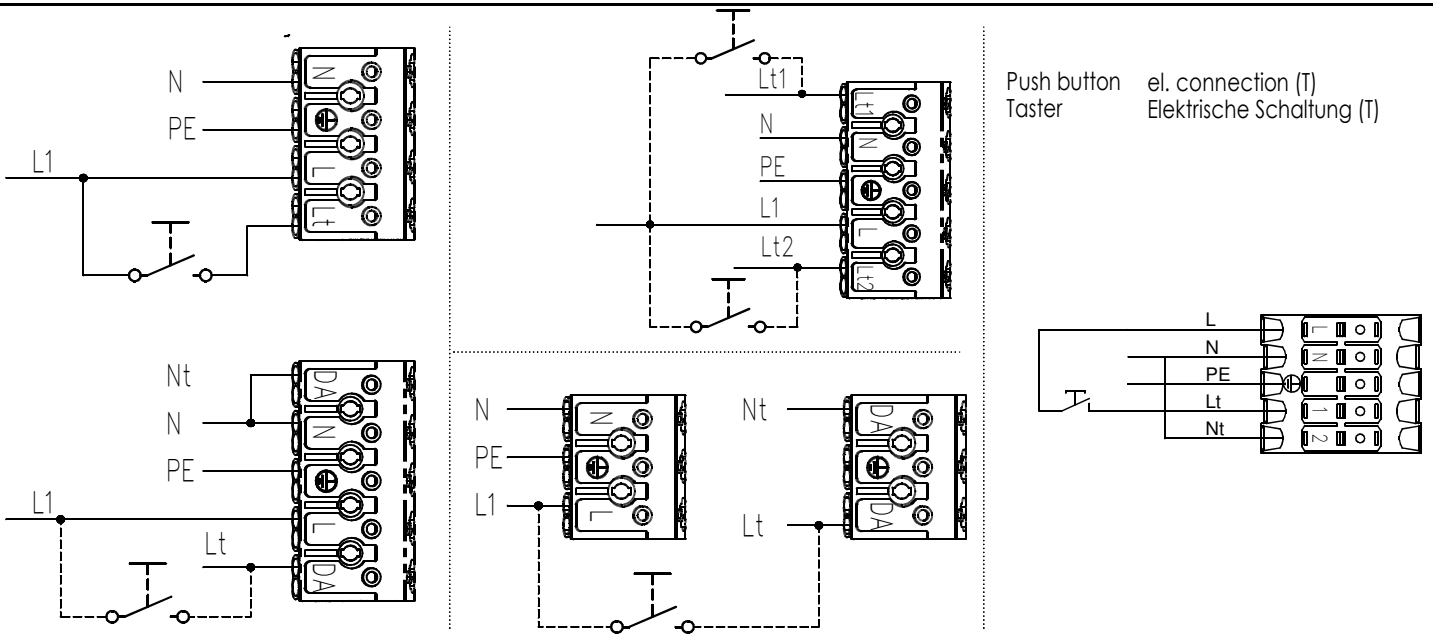

with cable connected mit angeschlossenem Kabel

