



## Luminaire

# Ravo

55-062C-10GJV/M/830, S +  
00-00155M3I



This circular downlight luminaire has been designed for LED sources with an efficacy of up to 130 lm/W. Ravo luminaires have been made of polycarbonate plastic and a passive aluminium heat sink. The IP44 class provided by the versions with clear or structured plexiglass protects against the penetration of water and foreign matter. Ravo luminaire with a wider beam angle is a good solution for commercial and social spaces, car showrooms and communication zones. Its great advantage is the possibility to fit into a hole up to 230 mm in diameter with the help of additional accessories.

## Technical drawing

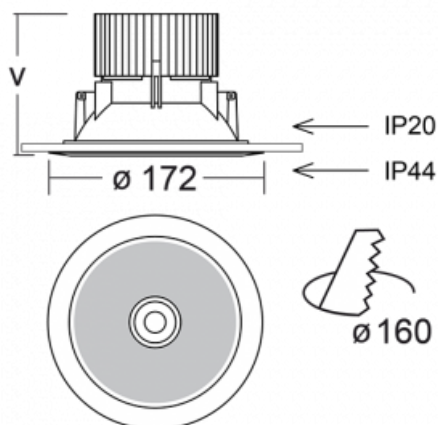

Type of installation	Recessed
Light distribution	Direct
Luminaire shape	Circular
Colour of the luminaires	Silver
Material	Plastic
Lifetime	L80/B20 50 000 hours
Warranty	5 years
Description of luminaires	Luminaire recessed
Dimensions	∅ 172 mm × 105 mm
Weight	0.5 kg
Type of optical system	Clear cover
Luminous flux*	3920 lm
Colour Temperature	3000 K warm white
Luminous efficacy	88 lm/W
MacAdam Light source	3
Colour rendering index	80
Beam angle	62°
UGR max. X=4H Y=8H, ρ=70,50,20	19.1

Luminaire power input*	44.5 W - 44 W
Connection of the luminaires	ON/OFF + 3h emergency
Electrical voltage	220-240V
Frequency	50/60Hz

 **CE** IP 44

\*±10 %

## Downloads

Installation instructions



Photos



## Accessories



**55-00001, B**  
black ring for Ravo



**55-0002, W**