



Luminaire

Ravo

55-062C-10GHV/840, S +
00-00151E



This circular downlight luminaire has been designed for LED sources with an efficacy of up to 130 lm/W. Ravo luminaires have been made of polycarbonate plastic and a passive aluminium heat sink. The IP44 class provided by the versions with clear or structured plexiglass protects against the penetration of water and foreign matter. Ravo luminaire with a wider beam angle is a good solution for commercial and social spaces, car showrooms and communication zones. Its great advantage is the possibility to fit into a hole up to 230 mm in diameter with the help of additional accessories.

Technical drawing

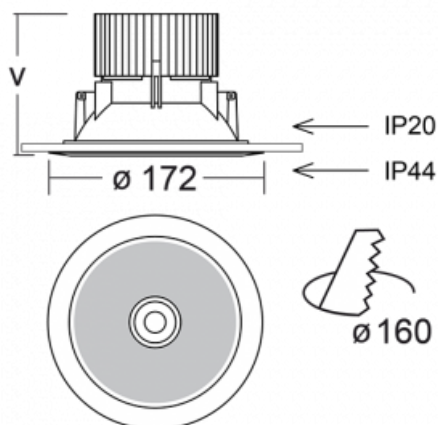

Type of installation	Recessed
Light distribution	Direct
Luminaire shape	Circular
Colour of the luminaires	Silver
Material	Plastic
Lifetime	L80/B10 50 000 hours
Warranty	5 years
Description of luminaires	Luminaire recessed
Dimensions	∅ 172 mm × 85 mm
Weight	0.5 kg
Type of optical system	Clear cover
Luminous flux*	1200 lm
Colour Temperature	4000 K cool white
Luminous efficacy	125 lm/W
MacAdam Light source	3
Colour rendering index	80
Beam angle	62°
UGR max. X=4H Y=8H, ρ=70,50,20	18.7

Luminaire power input*	9.6 W
Connection of the luminaires	ON/OFF
Electrical voltage	220-240V
Frequency	50/60Hz

 **CE** IP 44

*±10 %

Downloads

Installation instructions



Photos



Accessories



55-00001, B
black ring for Ravo



55-00002, W