



## Luminaire

# Lina35

35-500K-50GGD/840, B



The linear luminaires of the Lina35 family represent one of the thinnest profiles in our product range, while you can choose from several different lengths. The luminaires with direct distribution of light are available in the pendant, surface and recessed versions. Thanks to the option to extend and retract the opal diffuser, you can find the ideal combination of lights for a specific interior according to your needs. Thanks to this variability, Lina35 can be used in virtually all areas, but especially in the social, public and commercial ones. Luminaires with an extended diffuser diffuse their light into a significantly larger area thus helping to soften the entire interior.

## Technical drawing

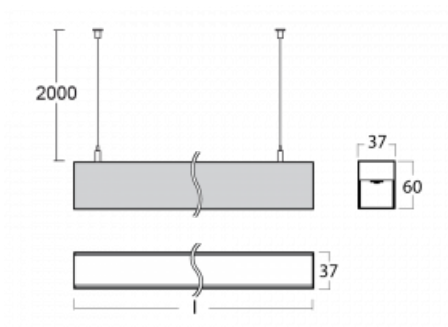

Type of installation	Suspended
Light distribution	Direct
Luminaire shape	Linear
Colour of the luminaires	Black
Material	Aluminium
Lifetime	L90/B50 50 000 hours
Warranty	60 months
Description of luminaires	Luminaire suspended
Dimensions	2805 mm × 37 mm × 60 mm
Weight	4.5 kg
Light source	LED MODUL
Type of optical system	Opal diffuser
Luminous flux	4980 lm ± 10 %
Colour Temperature	4000 K cool white
Luminous efficacy	90 lm/W
MacAdam Light source	2
Colour rendering index	80
UGR max. X=4H Y=8H, $\rho=70,50,20$	26.4

## Curve



Luminaire power input 55.1 W  $\pm$  10 %

Connection of the luminaires DALI dimmable

Electrical voltage 220-240V

Frequency 50/60Hz

  IP 20

## Downloads

Installation instructions



Photos

