



Luminaire

Gatu

21-001F-10GHV/M/840, S +
00-00151M3



If we combine a simple design with advanced functionality, we get the luminaires of Gatu family. The recessed luminaire with an adjustable reflector can be aimed at the required object. In addition to high-brightness LEDs with colour rendering of $Ra > 80$ or $Ra > 90$, the luminaire also contains a wide range of light sources. The RealWhite technology highlights the white, StrongColour highlights the selected colour, and RealColour with an extremely high colour rendering of $Ra > 97$ emphasizes the object's own colour. The illuminated object thus looks even more appealing, which makes Gatu luminaires suitable for commercial and cultural spaces, car showrooms and shop windows.

Technical drawing

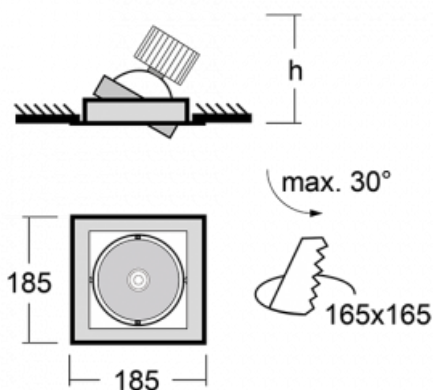

Type of installation	Recessed
Light distribution	Direct
Luminaire shape	Angular
Colour of the luminaires	Silver
Material	Sheet metal
Lifetime	L80/B10 50 000 hours
Warranty	60 months
Description of luminaires	Luminaire recessed
Dimensions	185 mm × 185 mm × 100 mm
Light source	LED MODUL
Type of optical system	Reflector
Luminous flux	1290 lm ± 10 %
Colour Temperature	4000 K cool white
Luminous efficacy	134 lm/W
MacAdam Light source	3
Colour rendering index	80
Beam angle	41°
Luminaire power input	9.6 W ± 10 %
Connection of the luminaires	Electronic ballast non-dimmable with 3h emergency
Electrical voltage	220-240V
Frequency	50/60Hz

  IP 20

Curve



Downloads

Installation instructions



Photos

