



## Luminaire

# Puri

143-080I-10GHD/830, W



We were thinking about how to achieve design purity, so we created a family of Puri recessed circular luminaires. Choose between the framed and frameless versions. You can mount it directly into the ceiling, without any cables or suspension fixtures. The framed version has a great advantage as it is very easy to disassemble. Using various diameters of the ceiling light, you can create combinations that will best suit the needs of your commercial spaces, offices, hotels or corridors. Puri blends in with the interior and can be easily combined with other families of circular luminaires.

## Technical drawing

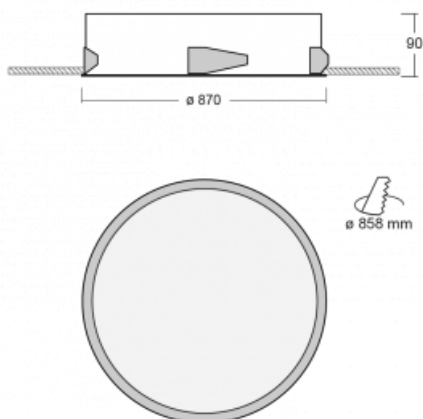

|  |                      |
|--|----------------------|
| Type of installation                   | Recessed             |
| Light distribution                     | Direct               |
| Luminaire shape                        | Circular             |
| Colour of the luminaires               | White                |
| Material                               | Aluminium            |
| Lifetime                               | L80/B20 50 000 hours |
| Warranty                               | 60 months            |
| Description of luminaires              | Luminaire recessed   |
| Dimensions                             | ø 870 mm × 90 mm     |
| Weight                                 | 8.8 kg               |
| Light source                           | LED MODUL            |
| Type of optical system                 | Microprisma          |
| Luminous flux                          | 10840 lm ± 10 %      |
| Colour Temperature                     | 3000 K warm white    |
| Luminous efficacy                      | 112 lm/W             |
| MacAdam Light source                   | 3                    |
| Colour rendering index                 | 80                   |
| UGR max. X=4H<br>Y=8H, $\rho=70,50,20$ | 19.6                 |

## Curve



Luminaire power input 97.2 W ± 10 %

Connection of the luminaires DALI dimmable

Electrical voltage 220-240V

Frequency 50/60Hz

⊕ CE IP 20

## Downloads

Installation instructions



Photos

