

Luminaire

Leira

131-821I-10GEQ/TC, W



Leira smart luminaires will win you over not only with their simple design, but mainly with several ways to control the light intensity. The version with non-dimmable electronic ballast will fit perfectly into areas with permanent lighting, e.g. a lobby while luminaires with a dimmer switch will be appreciated, for example, at the reception. The model with a motion sensor will provide automatic dimming in a meeting room. And the office? The best option there is the version with an addressing unit that dims and lights up all the luminaires in the room on the basis of the detection of people and keeps the room perfectly lit for work. Leira luminaires have been designed as a minimalist element suitable for most interiors with the possibility of rearranging the space without unnecessary installations when you only need to move the luminaire.

Type of installation	Table lamp
Light distribution	Direct-indirect
Luminaire shape	Angular
Colour of the luminaires	White
Material	Aluminium
Lifetime	L80/B20 50 000 hours
Warranty	60 months
Description of luminaires	Luminaire table lamp
item description	13-721I-10GEQ/TC, W + 13-7012, W
Dimensions	615 mm × 325 mm × 1305 mm
Light source	LED MODUL
Type of optical system	Microprisma
Luminous flux	7610 lm ± 10 %
Colour Temperature	2700 K - 6500 K Tunable White
Luminous efficacy	105 lm/W
MacAdam Light source	3
Colour rendering index	90
UGR max. X=4H Y=8H, $\rho=70,50,20$	14.7

Technical drawing

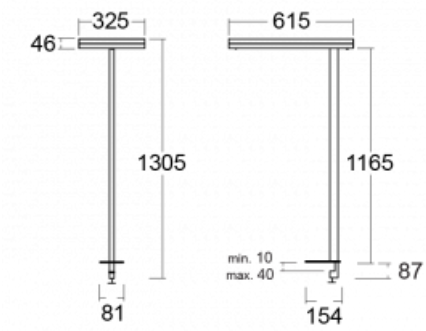

Luminaire power input 72.6 W \pm 10 %

Connection of the luminaires DALI DT8

Electrical voltage 220-240V

Frequency 50/60Hz

⊕ CE IP 20

Curve

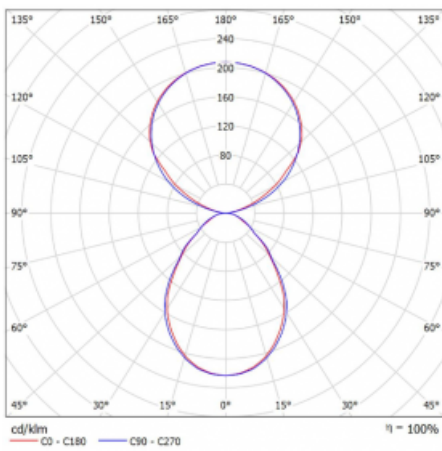

Downloads

Installation instructions



Photos

