



Luminaire

Zuli

121-531M-30GEE/840, W



Do you remember the buzzing and flickering lights of your classroom? Fortunately these are long gone. Zuli pendant and surface-mounted LED luminaires ensure comfortable lighting in the classroom, offices and hospitals without these annoyances. These luminaires have direct or direct-indirect emission, with a choice of four lengths and microprism optics, grid and opal diffuser.

Technical drawing

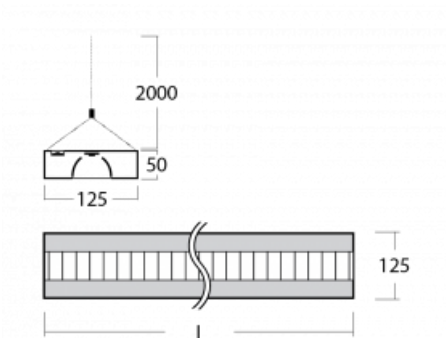

Type of installation	Suspended
Light distribution	Direct-indirect
Luminaire shape	Angular
Colour of the luminaires	White
Material	Aluminium
Lifetime	L80/B20 50 000 hours
Warranty	60 months
Description of luminaires	Luminaire suspended
Dimensions	1705 mm × 125 mm × 50 mm
Weight	4.8 kg
Light source	LED MODUL
Type of optical system	Matt parabolic louvre
Luminous flux	7260 lm ± 10 %
Colour Temperature	4000 K cool white
Luminous efficacy	131 lm/W
MacAdam Light source	2
Colour rendering index	80
UGR max. X=4H Y=8H, $\rho=70,50,20$	12.7

Curve

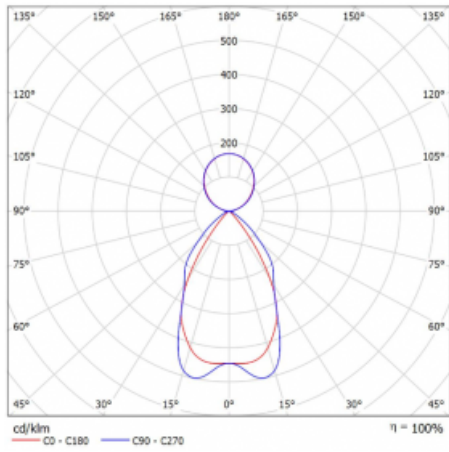

Luminaire power input 55.6 W \pm 10 %

Connection of the luminaires Electronic ballast non-dimmable

Electrical voltage 220-240V

Frequency 50/60Hz

⊕ CE IP 20

Downloads

Installation instructions



Photos

