



## Luminaire

# Zuli

121-501D-20GGD/840, W



Do you remember the buzzing and flickering lights of your classroom? Fortunately these are long gone. Zuli pendant and surface-mounted LED luminaires ensure comfortable lighting in the classroom, offices and hospitals without these annoyances. These luminaires have direct or direct-indirect emission, with a choice of four lengths and microprism optics, grid and opal diffuser.

## Technical drawing



Type of installation	Suspended
Light distribution	Direct-indirect
Luminaire shape	Angular
Colour of the luminaires	White
Material	Aluminium
Lifetime	L80/B20 50 000 hours
Warranty	60 months
Description of luminaires	Luminaire suspended
item description	wall washer
Dimensions	1145 mm × 125 mm × 50 mm
Light source	LED MODUL
Type of optical system	Asymmetric reflector
Luminous flux	5840 lm ± 10 %
Colour Temperature	4000 K cool white
Luminous efficacy	115 lm/W
MacAdam Light source	3
Colour rendering index	80
Luminaire power input	50.6 W ± 10 %
Connection of the luminaires	DALI dimmable
Electrical voltage	220-240V
Frequency	50/60Hz

 **CE** IP 20

# Curve

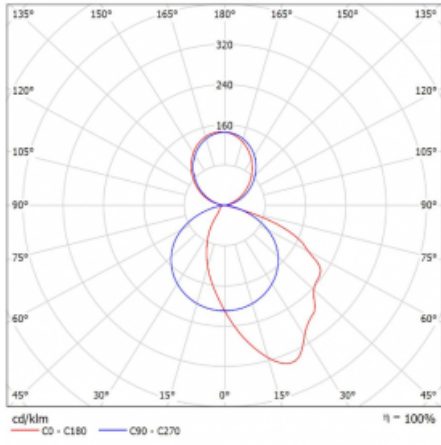

## Downloads

Installation instructions



Photos

