



Luminaire

Lina80-S

11S-501B-35GGD/840, W

EPD®

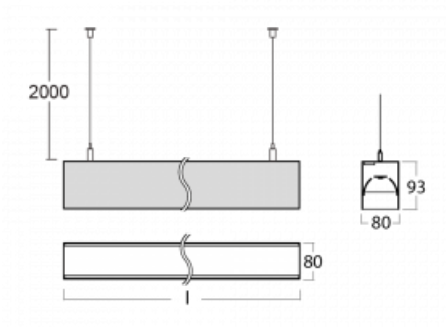
Lina80-S luminaires are available in recessed, surface, suspended or wall mounted versions, including the illuminated corner segments. Lina80-S system luminaire can be used to create different shapes or long lines, with special joints that prevent any light to shine through, creating thus a seamless visual effect, suitable for small offices as well as big halls.

Technical drawing

Type of installation	Wall mounted, Suspended
----------------------	-------------------------

Light distribution	Direct-indirect
--------------------	-----------------

Luminaire shape	Linear
-----------------	--------

Colour of the luminaires	White
--------------------------	-------

Material	Aluminium
----------	-----------

Lifetime	L90/B50 50 000 hours
----------	----------------------

Warranty	5 years
----------	---------

Description of luminaires	Luminaire wall mounted/suspended
---------------------------	----------------------------------

Dimensions	1964 mm × 80 mm × 93 mm
------------	-------------------------

Light source	LED MODUL
--------------	-----------

Type of optical system	MP PRO UGR
------------------------	------------

Luminous flux*	8970 lm
----------------	---------

Colour Temperature	4000 K cool white
--------------------	-------------------

Luminous efficacy	133 lm/W
-------------------	----------

MacAdam Light source	2
----------------------	---

Colour rendering index	80
------------------------	----

UGR max. X=4H	15.4
---------------	------

Y=8H, $\rho=70,50,20$	
-----------------------	--

Luminaire power input* 67.2 W

Connection of the luminaires DALI

Electrical voltage 220-240V

Frequency 50/60Hz

  IP 40

*±10 %

Downloads

Installation instructions



Photos



Accessories

00-00200, N
 straight connector

00-00300, N
 wire suspension
 2000mm

00-00301, N
 wire suspension
 4000mm

00-00302, N
 wire suspension
 6000mm

00-00355, K
 cable 5x0,75 2000mm

00-00356, K
 cable 5x0,75 4000mm

00-00363, K
 cable 5x1,5 2000mm

00-00364, K
 cable 5x1,5 4000mm

00-00365, K
 cable 5x1,5 6000mm

00-00366, K
 cable 7x0,75 2000mm

00-00367, K
 cable 7x0,75 4000mm

00-00368, K
 cable 7x0,75 6000mm

00-00370, W
 ceiling cup 80x80x32mm

00-01200, F
 Accessory for gear-tray
 release

00-20101, W
 2xend cap - metal, 5-
 conductor terminal box,
 grommet; Lipo80/Lina80

00-20103, W
 2xend cap - plastic, 5-
 conductor terminal box,
 grommet; Lipo80/Lina80

00-20700, W
 2 pcs of wall fastening
 Lipo/Lina

00-51301, W
 set for suspension into
 3-phase track, dimmable
 luminaires