



## Luminaire

# Lina80-S

11S-501B-20GGE/840, S



EPD®

Lina80-S luminaires are available in recessed, surface, suspended or wall mounted versions, including the illuminated corner segments. Lina80-S system luminaire can be used to create different shapes or long lines, with special joints that prevent any light to shine through, creating thus a seamless visual effect, suitable for small offices as well as big halls.

## Technical drawing

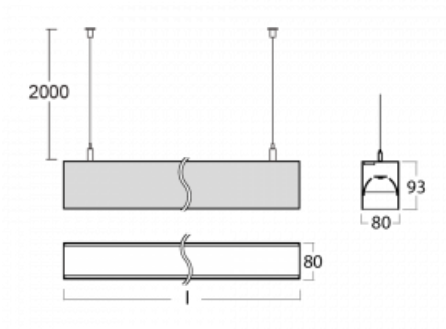

Type of installation	Wall mounted, Suspended
Light distribution	Direct-indirect
Luminaire shape	Linear
Colour of the luminaires	Silver
Material	Aluminium
Lifetime	L90/B50 50 000 hours
Warranty	5 years
Description of luminaires	Luminaire wall mounted/suspended
Dimensions	1122 mm × 80 mm × 93 mm
Light source	LED MODUL
Type of optical system	MP PRO UGR
Luminous flux*	4830 lm
Colour Temperature	4000 K cool white
Luminous efficacy	135 lm/W
MacAdam Light source	2
Colour rendering index	80
UGR max. X=4H Y=8H, ρ=70,50,20	15.7

Luminaire power input*	35.8 W
Connection of the luminaires	ON/OFF
Electrical voltage	220-240V
Frequency	50/60Hz

 **CE** IP 40

\*±10 %

## Downloads

Installation instructions



Photos



**Accessories**

**00-00200, N**  
 straight connector

**00-00300, N**  
 wire suspension  
 2000mm

**00-00301, N**  
 wire suspension  
 4000mm

**00-00302, N**  
 wire suspension  
 6000mm

**00-00352, K**  
 cable 3x0,75 2000mm

**00-00355, K**  
 cable 5x0,75 2000mm

**00-00356, K**  
 cable 5x0,75 4000mm

**00-00358, K**  
 cable 3x0,75 4000mm

**00-00360, K**  
 cable 3x0,75 6000mm

**00-00363, K**  
 cable 5x1,5 2000mm

**00-00364, K**  
 cable 5x1,5 4000mm

**00-00365, K**  
 cable 5x1,5 6000mm

**00-00370, S**  
 ceiling cup 80x80x32mm

**00-01200, F**  
 Accessory for gear-tray  
 release

**00-20101, S**  
 2xend cap - metal, 5-  
 conductor terminal box,  
 grommet; Lipo80/Lina80

**00-20103, S**  
 2xend cap - plastic, 5-  
 conductor terminal box,  
 grommet; Lipo80/Lina80

**00-20700, S**  
 2 pcs of wall fastening  
 Lipo/Lina

**00-51300, S**  
 set for suspension into  
 3-phase track, non-  
 dimmable luminaires