



Luminaire

Indi

108-531K-77FZD/840, B



The Indi luminaire, designed by Matúš Opálka, has won a number of awards, such as the Red Dot Award, the iF Design Award and the German Design Award. This circular luminaire directindirect distribution of light and dimensions from 1 to 4 meters can be used in meeting rooms, all types of corridors, conference halls and social spaces. The aluminium profile has been fitted with powerful LED boards. The indirect distribution of light on two sides creates a pleasant soft light with adjustable intensity.

Design Matúš Opálka

Technical drawing

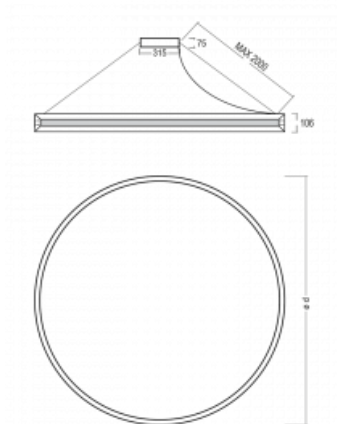

Type of installation	Suspended
Light distribution	Direct-indirect
Luminaire shape	Circular
Colour of the luminaires	Black
Material	Aluminium
Lifetime	L80/B20 50 000 hours
Warranty	5 years
Description of luminaires	Luminaire suspended
Dimensions	ø 2466 mm × 106 mm
Weight	19.5 kg
Light source	LED MODUL
Type of optical system	Opal diffuser
Luminous flux	20820 lm ± 10 %
Colour Temperature	4000 K cool white
Luminous efficacy	87 lm/W
Colour rendering index	80
UGR max. X=4H Y=8H, ρ=70,50,20	20.1
Luminaire power input	238 W ± 10 %
Connection of the luminaires	DALI dimmable
Electrical voltage	220-240V
Frequency	50/60Hz

 **CE** IP 20

Curve

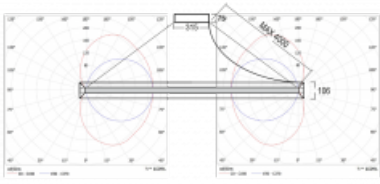

Downloads

Installation instructions



Photos



Accessories



108-0004
Tie-down strap for
INDI circle