



Luminaire

Lina80-S

05S-000K-25GHTD/840, B

EPD[®]

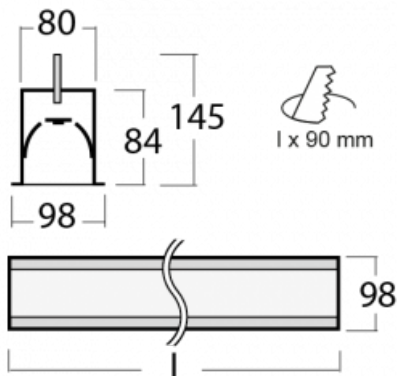
Lina80-S luminaires are available in recessed, surface, suspended or wall mounted versions, including the illuminated corner segments. Lina80-S system luminaire can be used to create different shapes or long lines, with special joints that prevent any light to shine through, creating thus a seamless visual effect, suitable for small offices as well as big halls.

Technical drawing

Type of installation	Recessed
Light distribution	Direct
Luminaire shape	Linear
Colour of the luminaires	Black
Material	Aluminium
Lifetime	L80/B10 70 000 hours
Warranty	60 months
Description of luminaires	Luminaire recessed
Dimensions	1403 mm × 98 mm × 84 mm
Light source	LED MODUL
Type of optical system	Opal diffuser
Luminous flux	6690 lm ± 10 %
Colour Temperature	4000 K cool white
Luminous efficacy	122 lm/W
MacAdam Light source	2
Colour rendering index	80
UGR max. X=4H Y=8H, ρ=70,50,20	26.7

Luminaire power input	54.8 W \pm 10 %
Connection of the luminaires	DALI or by switch (touch dimm) dimmable
Electrical voltage	220-240V
Frequency	50/60Hz

 **CE** IP 40

Downloads

Installation instructions



Photos



Accessories



00-00101, B
2xend cap - metal, 5-
conductor terminal box,
grommet; Lipo80



00-00200, N
straight connector



00-01200, F
Accessory for gear-tray
release