



Luminaire

Lina80

05-500K-80GEE/830, B



EPD®

Lina80 luminaires with an easy L-Click system feature an elegant and classic linear design with excellent illumination characteristics with both ceiling mounted and suspended versions, allowing them to fit into almost any space. Lina80 lighting is the right solution for offices, business, social and cultural spaces, as well as households and restaurants. With Tunable White, you set the white color temperature according to the time of day. The light thus provides optimal light helping you to focus on and concentrate on the work.

Technical drawing

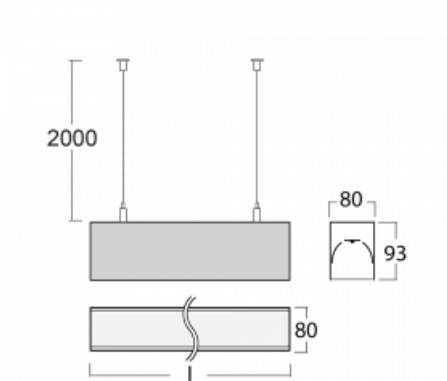

Type of installation	Suspended
Light distribution	Direct
Luminaire shape	Linear
Colour of the luminaires	Black
Material	Aluminium
Lifetime	L90/B50 60 000 hours
Warranty	60 months
Description of luminaires	Luminaire suspended
Dimensions	4493 mm × 80 mm × 93 mm
Light source	LED MODUL
Type of optical system	Opal diffuser
Luminous flux	8430 lm ± 10 %
Colour Temperature	3000 K warm white
Luminous efficacy	142 lm/W
MacAdam Light source	2
Colour rendering index	80
UGR max. X=4H Y=8H, ρ=70,50,20	23.5

Luminaire power input 59.2 W \pm 10 %

Connection of the luminaires Electronic ballast non-dimmable

Electrical voltage 220-240V

Frequency 50/60Hz

   IP 40

Downloads

Installation instructions



Photos

