



**Luminaire**

# Lina60-S

04S-000K-10GGD/840, W

**EPD®**

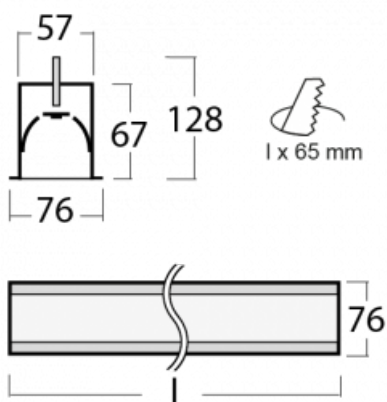
You will appreciate the L-Click system on the Lina60-S luminaire with a direct light distribution, which effectively saves you both time and money. How? The module simply clicks into the profile, so a lot of work is saved during assembly. This solution also prevents the direct touch of the LED technology and lengthens its operating life. The Lina60-S lighting system can be assembled creating endless lines and a big variety of shapes. In addition to great power output, the luminaire also has a great price. It will find its use in commercial, social and public spaces.

**Technical drawing**

Type of installation	Recessed
Light distribution	Direct
Luminaire shape	Linear
Colour of the luminaires	White
Material	Aluminium
Lifetime	L90/B50 50 000 hours
Warranty	5 years
Description of luminaires	Luminaire recessed
Dimensions	561 mm × 76 mm × 67 mm
Weight	1.9 kg
Light source	LED MODUL
Type of optical system	Opal diffuser
Luminous flux*	1630 lm
Colour Temperature	4000 K cool white
Luminous efficacy	131 lm/W
MacAdam Light source	2
Colour rendering index	80
UGR max. X=4H Y=8H, $\rho=70,50,20$	26.5

## Curve



Luminaire power input\* 12.4 W

Connection of the luminaires DALI

Electrical voltage 220-240V

Frequency 50/60Hz

⊕ CE IP 40

\*±10 %

## Downloads

Installation instructions



Photos



## Accessories



**00-00500**  
wire for emergency  
lighting XX-XXXX-20



**04-00101, W**  
2xend cap - metal, 5-  
conductor terminal box,  
grommet



**04-00200, N**  
straight connector



**04-01200, F**  
Accessory for gear-tray  
release